

Revision History

Revision	Date	Comments
1306	2013-06-09	初次版本
1412	2014-12-22	1.增加加密芯片 2.改为两片内存 3.改进RESET电路 4.使用eMMC 5.0

Index

01:Revision History and Index	1
02:Function Block Diagram	2
03:S5PV4412 (SYS)/Boot Option	3
04:S5PV4412 (Memory)	4
05:S5PV4412 (Media)	5
06:S5PV4412 (Power)	6
07:NAND/iNAND Flash	7
08:Memory (DDR3)	8
09:Reset/JTAG/SD/Clock	9

FriendlyARM

Designed by FriendlyARM in Guangzhou
All rights reserved | <http://www.arm9.net>
广州友善之臂计算机科技有限公司

Title		
Tiny4412		
Size A3	Document Number <Doc>	Rev
Date:	Wednesday, September 23, 2015	Sheet 1 of 15

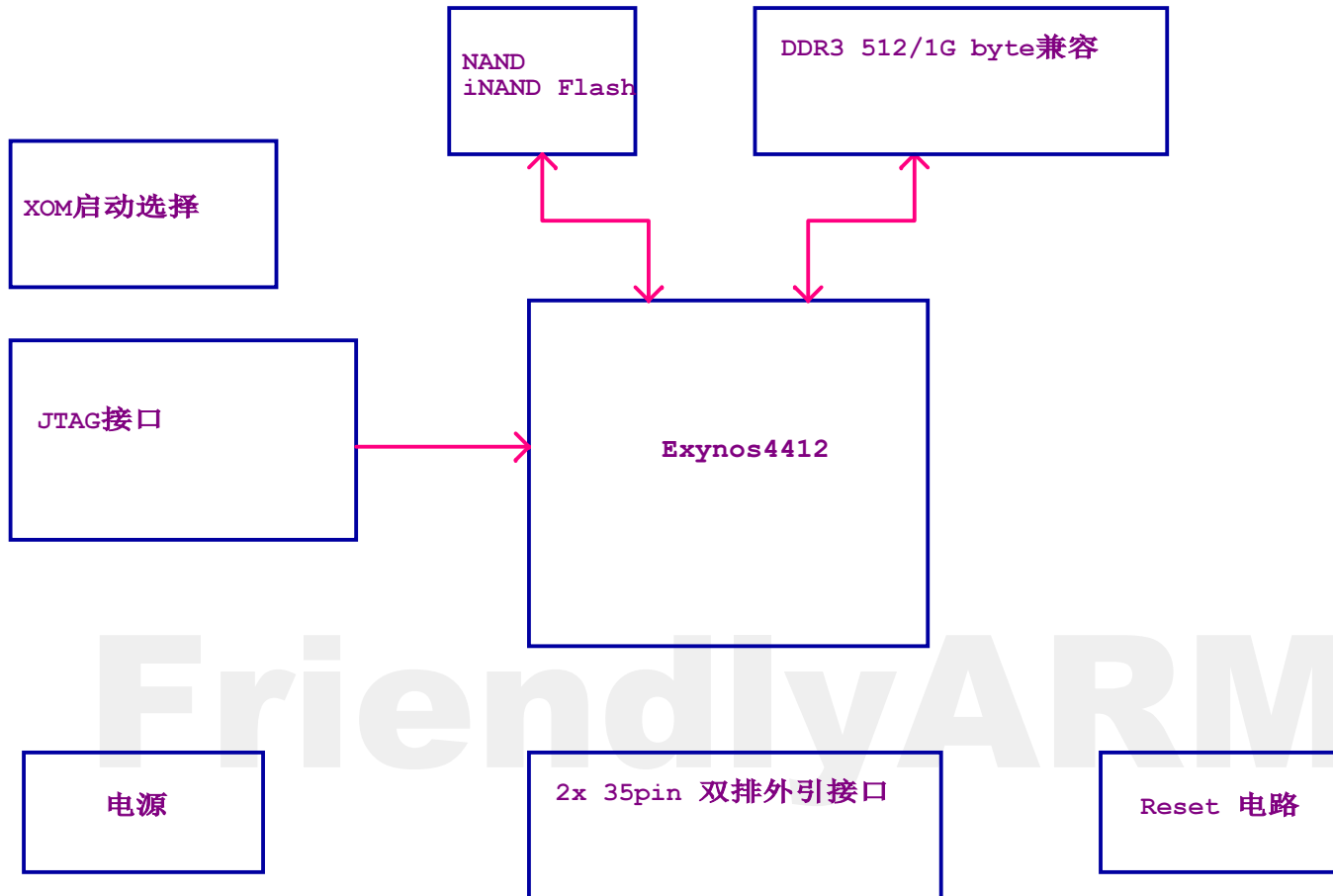

FriendlyARM

Designed by FriendlyARM in Guangzhou
 All rights reserved | <http://www.arm9.net>
 广州友善之臂计算机科技有限公司

Title		Tiny4412	
Size	Document Number	Rev	
A3			
Date:	Wednesday, September 23, 2015	Sheet	2 of 15

D

D

C

C

B

B

A

A

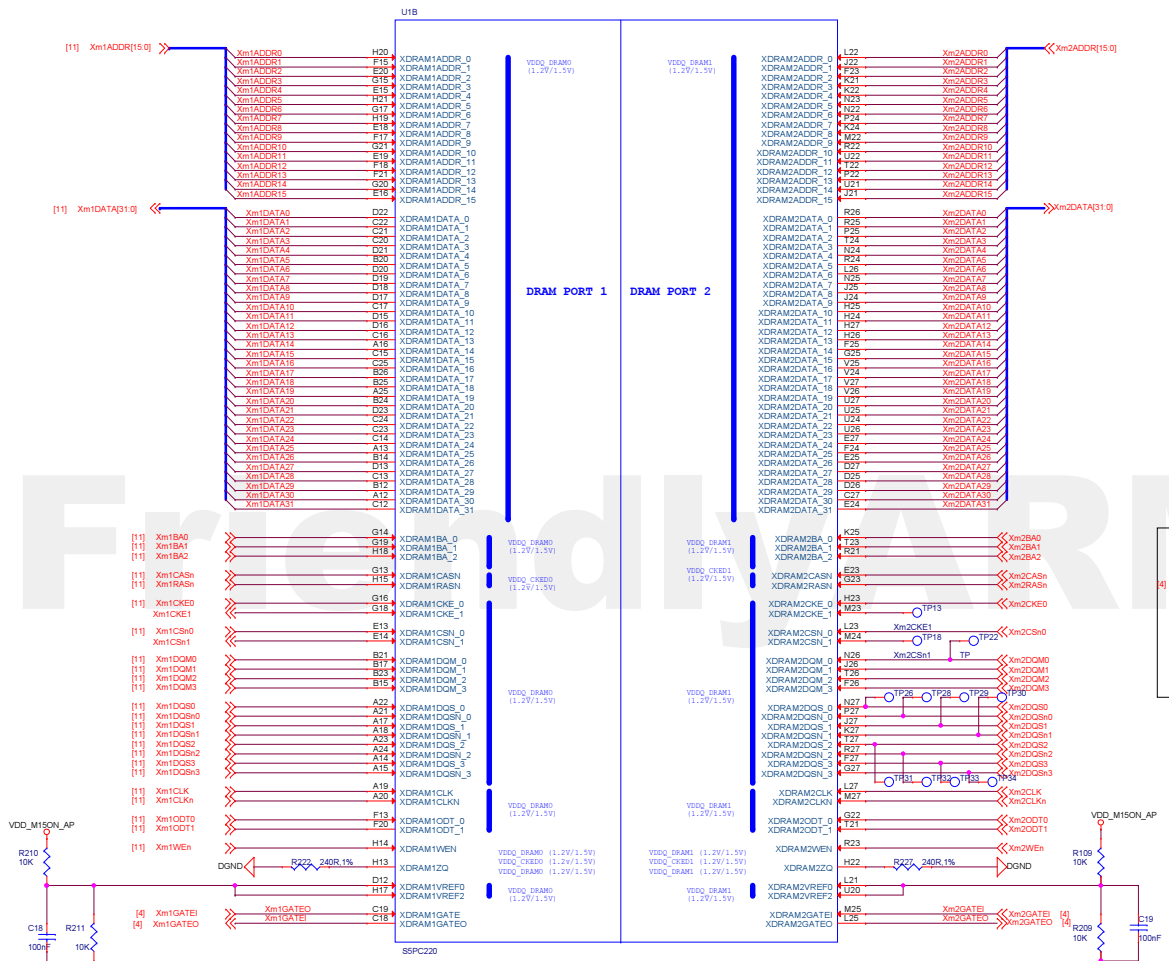

[4] Xn1GATE1 Xn1GATE2 Xn1GATE3 Xn1GATE4 [4]

线与clk等长

[4] Xn2GATE1 Xn2GATE2 Xn2GATE3 Xn2GATE4 [4]

线与clk等长

Designed by FriendlyARM in Guangzhou
 All rights reserved | <http://www.arm9.net>
 广州友善之臂计算机科技有限公司

File	Tiny4412		
Size	Document Number		Rev
AC			
Date	Wednesday, October 08, 2014	Sheet	4 of 15

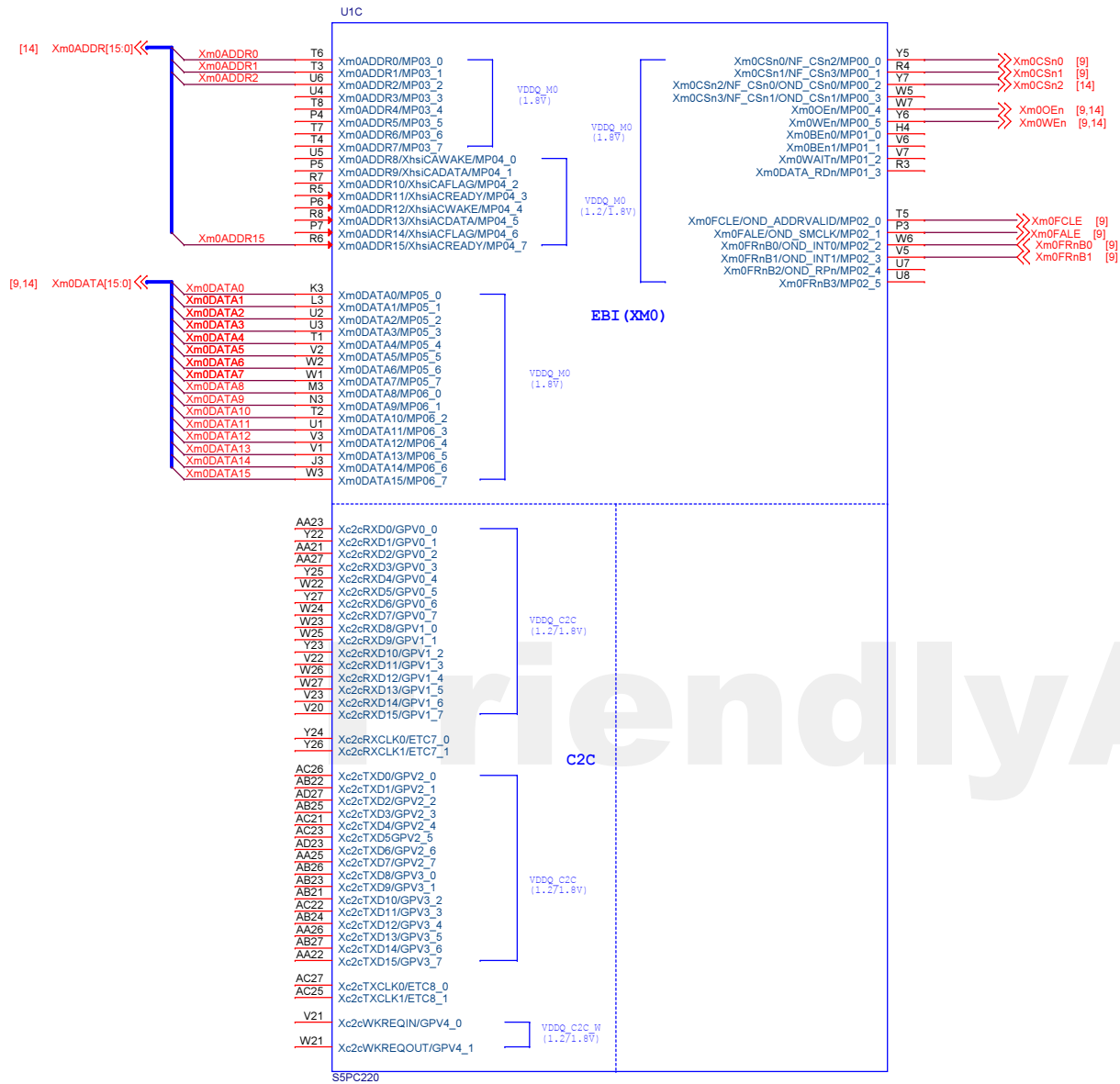

Designed by FriendlyARM in Guangzhou
 All rights reserved | <http://www.arm9.net>
 广州友善之臂计算机科技有限公司

Title			Tiny4412
Size	Document Number	Rev	
A3	<Doc>		
Date:	Monday, September 22, 2014	Sheet	5 of 15

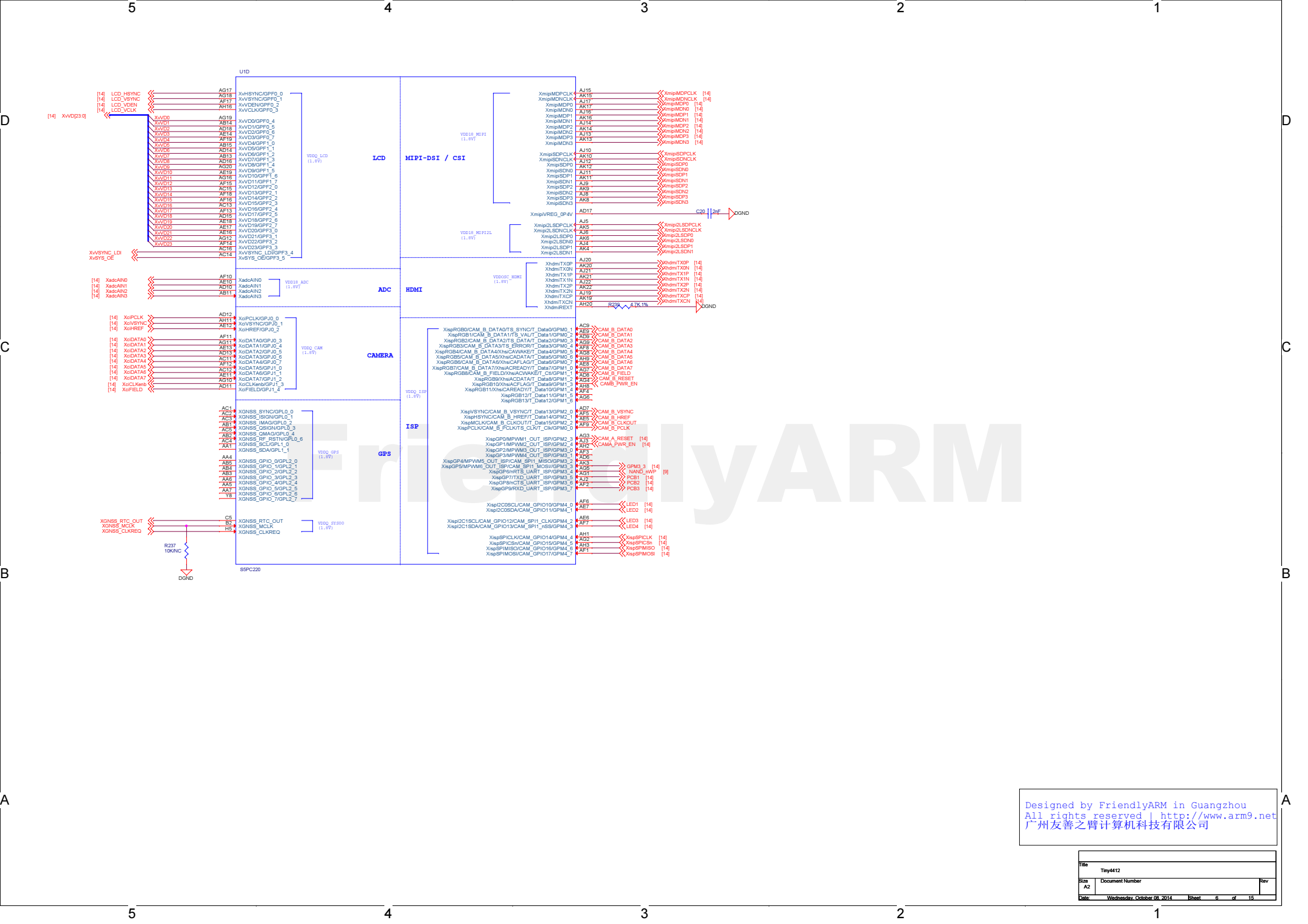

Designed by FriendlyARM in Guangzhou
 All rights reserved | <http://www.arm9.net>
 广州友善之臂计算机科技有限公司

File		Tiny4412	
Size	A2	Document Number	Rev
Date		Wednesday, October 08, 2014	Sheet 6 of 16

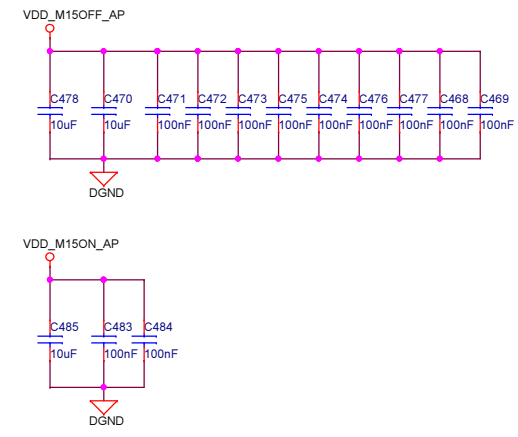
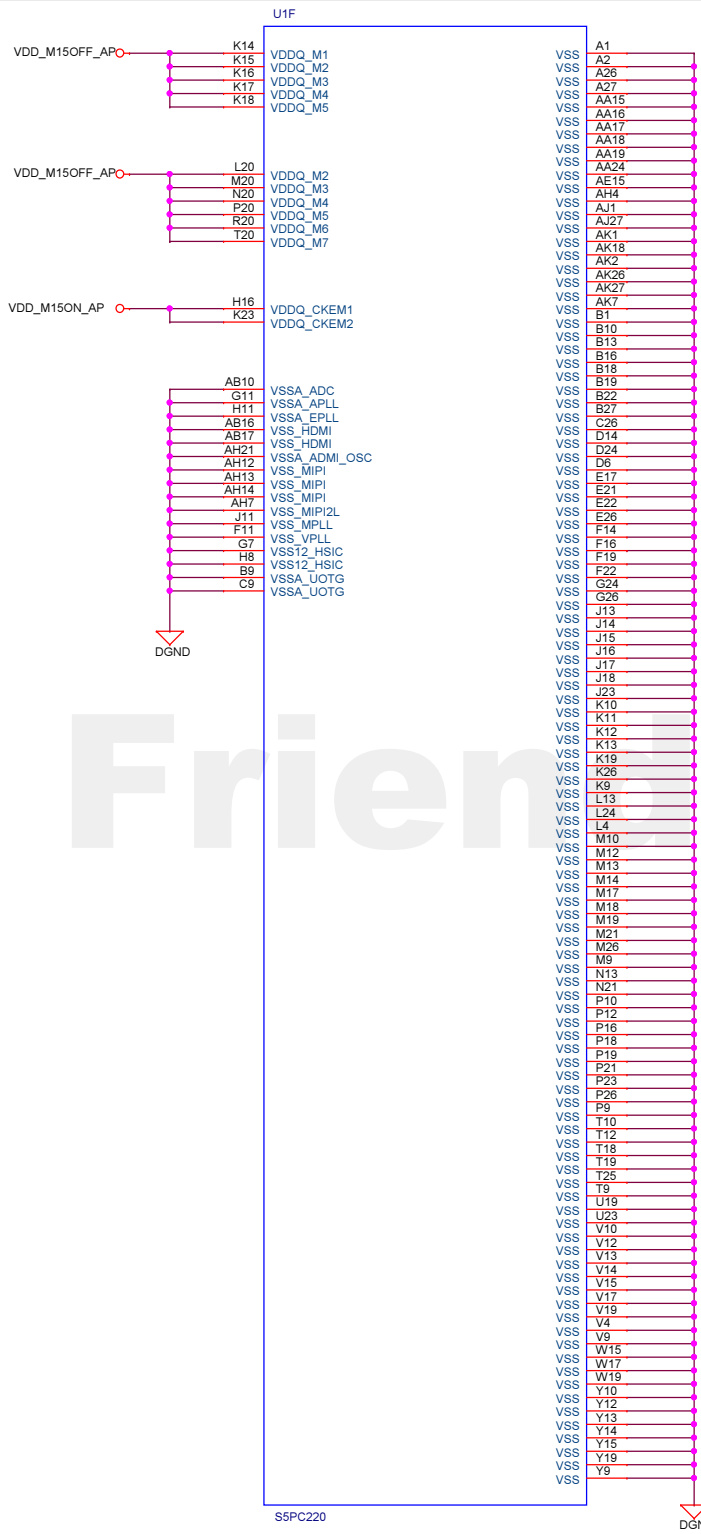

Designed by FriendlyARM in Guangzhou
 All rights reserved | <http://www.arm9.net>
 广州友善之臂计算机科技有限公司

Title			Tiny4412		
Size	Document Number				Rev
A3	<Doc>				
Date:	Wednesday, October 08, 2014	Sheet	8	of	15

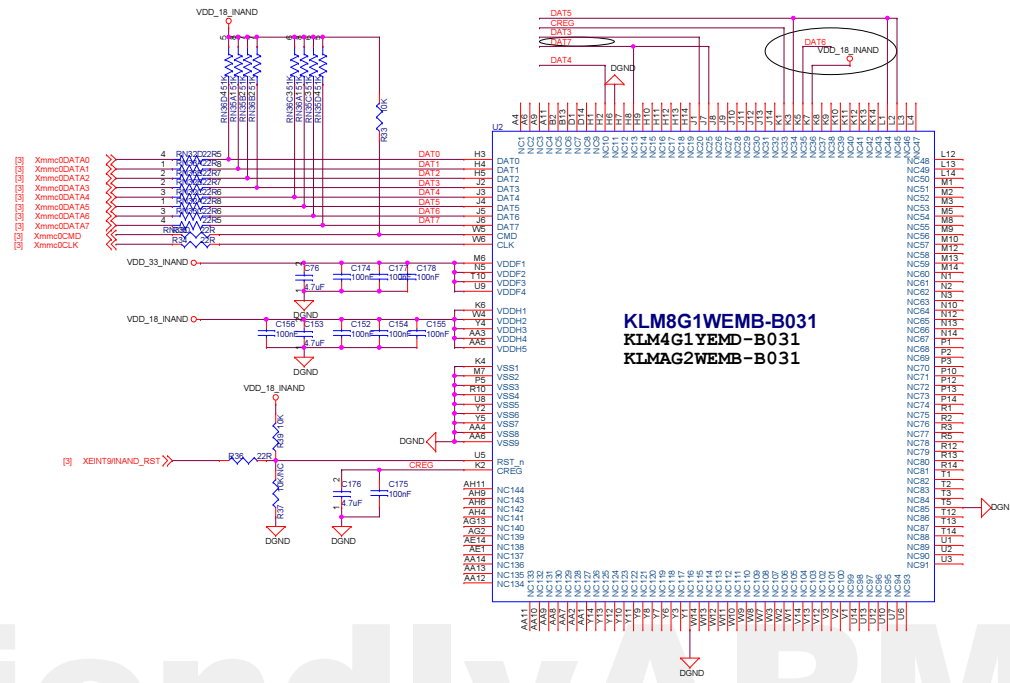
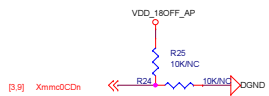
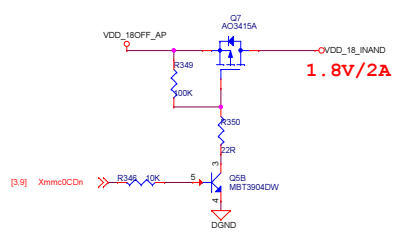
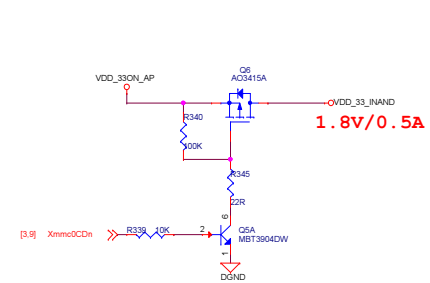

FriendlyARM

NAND Flash memory

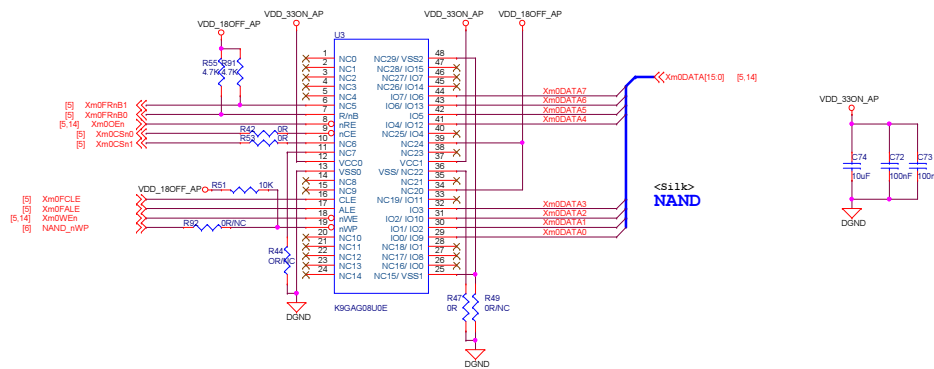

Designed by FriendlyARM in Guangzhou
 All rights reserved | <http://www.arm9.net>
 广州友善之臂计算机科技有限公司

Title		Tiny4412	
Size	A2	Document Number	<Doc>
Date:	Tuesday, December 09, 2014	Sheet	9 of 15

D

D

C

C

B

B

A

A

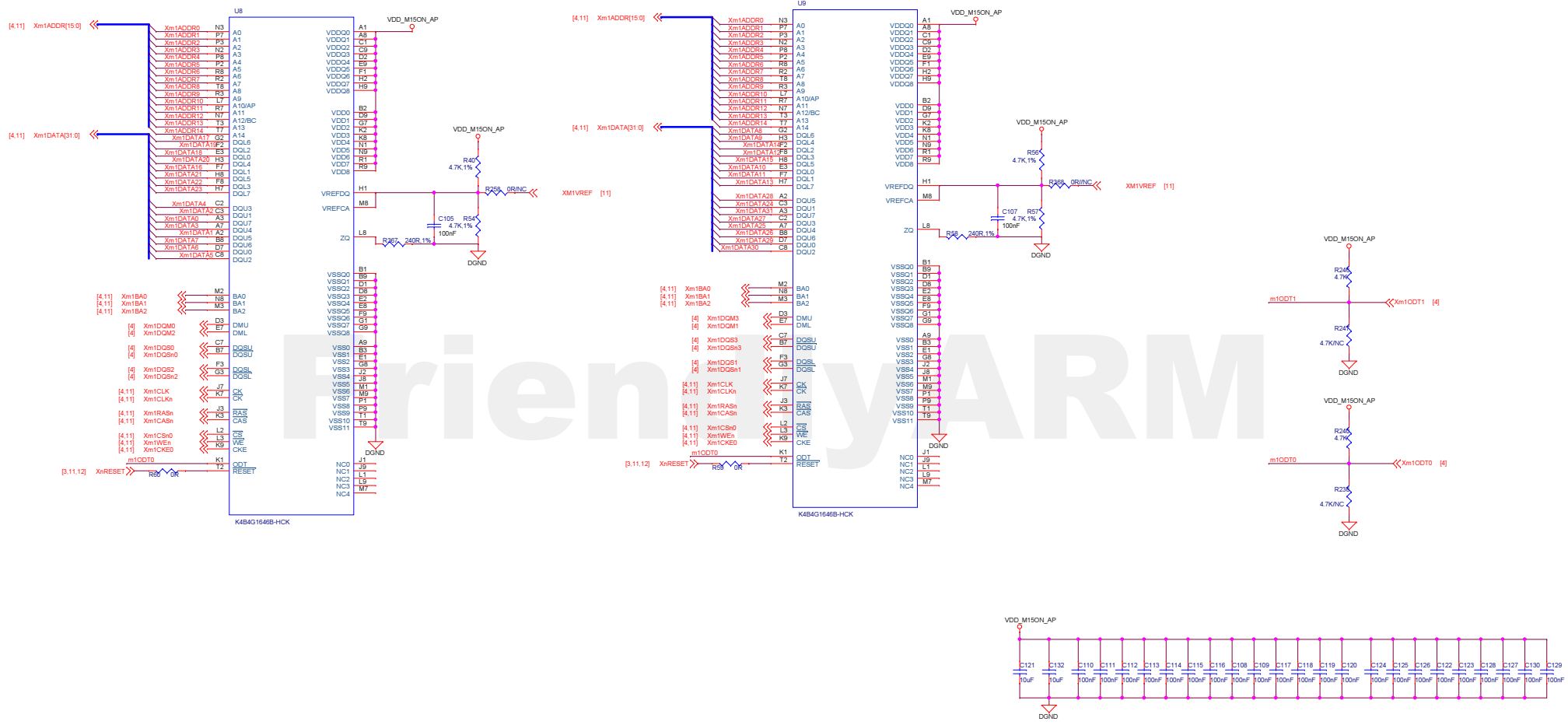

File	<Tble>
Size	A2
Document Number	<Doc>
Date	Tuesday, December 09, 2014
Sheet	11 of 15
Row	<Row Code>

复位电路

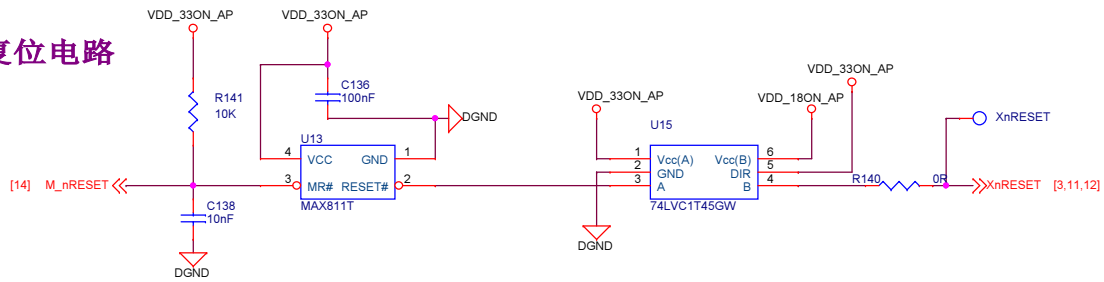

JTAG电路

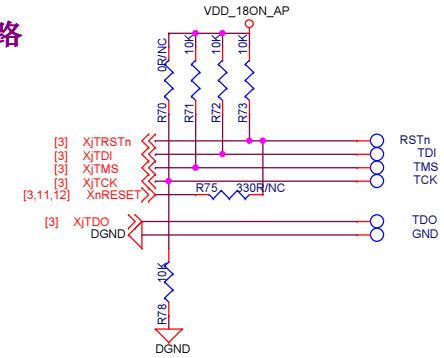

FriendlyARM

For PLL

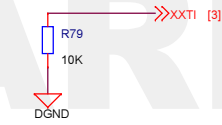

For USB HOST

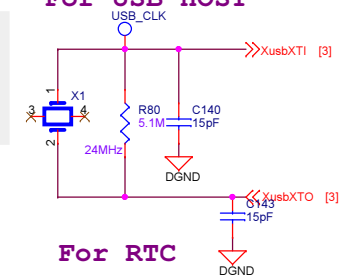

For VEDIO

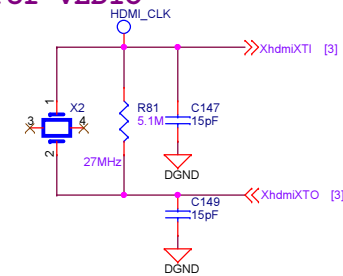

For RTC

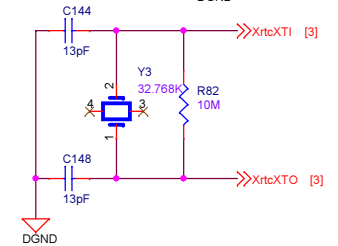

Designed by FriendlyARM in Guangzhou
 All rights reserved | <http://www.arm9.net>
 广州友善之臂计算机科技有限公司

Title		Tiny4412	
Size	A3	Document Number	Rev
Date:	Thursday, November 20, 2014	Sheet	12 of 15

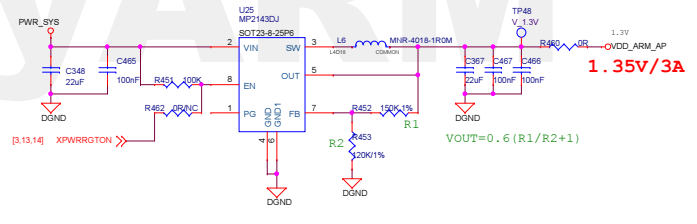
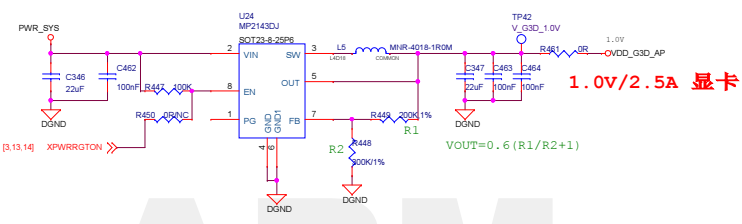
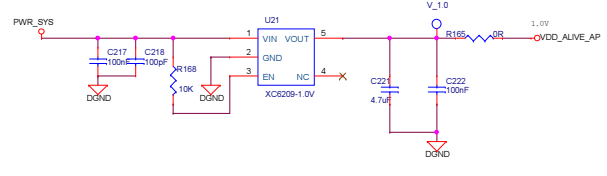
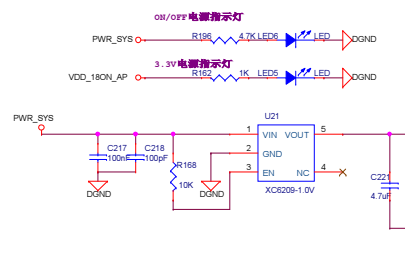
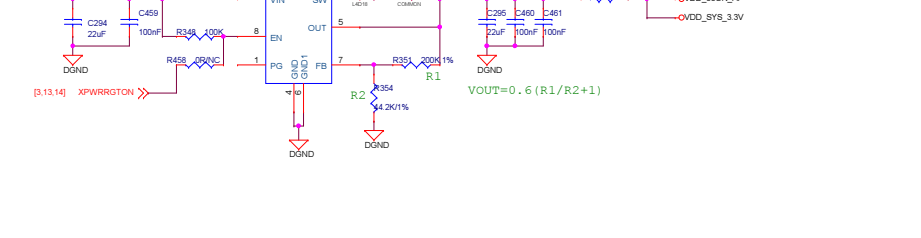
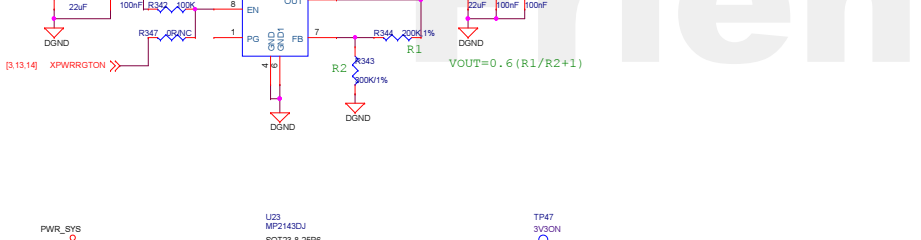
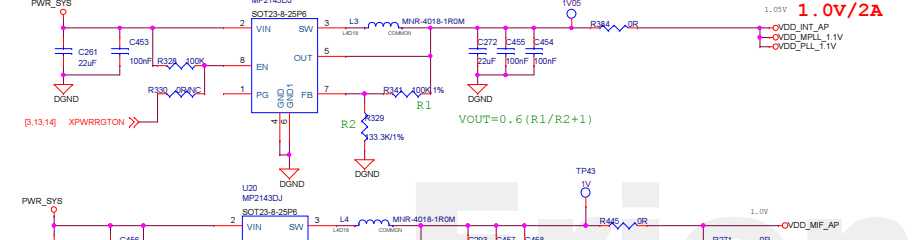
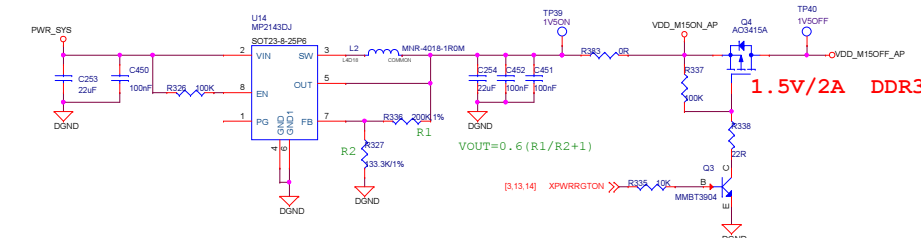
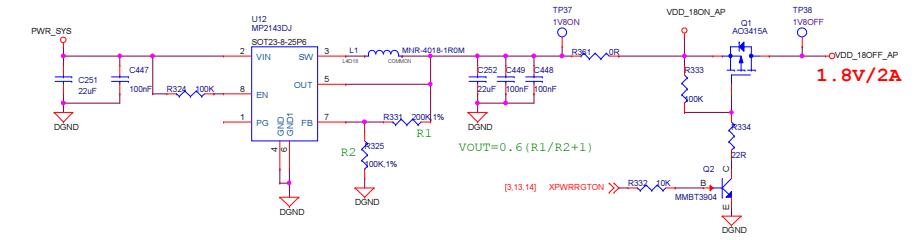

Designed by FriendlyARM in Guangzhou
 All rights reserved | <http://www.arm9.net>
 广州友善之臂计算机科技有限公司

File	Tiny4412
Sheet	Document Number
Date	Thursday, September 10, 2015 Sheet 13 of 15

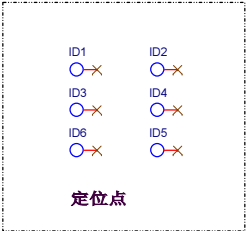

FriendlyARM

Designed by FriendlyARM in Guangzhou
 All rights reserved | <http://www.arm9.net>
 广州友善之臂计算机科技有限公司

Title		
Tiny4412		
Size	Document Number	Rev
A3	ID Mark/Fixed Hold	
Date:	Monday, September 22, 2014	Sheet 15 of 15