

# S132 SoftDevice

## SoftDevice Specification

v6.1

# Contents

Revision history	v
<b>1 S132 SoftDevice</b>	<b>11</b>
<b>2 Documentation</b>	<b>14</b>
<b>3 Product overview</b>	<b>15</b>
<b>4 Application programming interface</b>	<b>17</b>
4.1 Events - SoftDevice to application	17
4.2 Error handling	17
<b>5 SoftDevice Manager</b>	<b>19</b>
5.1 SoftDevice enable and disable	19
5.2 Clock source	19
5.3 Power management	20
5.4 Memory isolation and runtime protection	20
<b>6 System on Chip library</b>	<b>23</b>
<b>7 System on Chip resource requirements</b>	<b>25</b>
7.1 Hardware peripherals	25
7.2 Application signals – software interrupts	27
7.3 Programmable peripheral interconnect	28
7.4 SVC number ranges	28
7.5 Peripheral runtime protection	29
7.6 External and miscellaneous requirements	29
<b>8 Flash memory API</b>	<b>30</b>
<b>9 Multiprotocol support</b>	<b>33</b>
9.1 Non-concurrent multiprotocol implementation	33
9.2 Concurrent multiprotocol implementation using the Radio Timeslot API	33
9.2.1 Request types	33
9.2.2 Request priorities	34
9.2.3 Timeslot length	34
9.2.4 Scheduling	34
9.2.5 High-frequency clock configuration	34
9.2.6 Performance considerations	35
9.2.7 Radio Timeslot API	35
9.3 Radio Timeslot API usage scenarios	38
9.3.1 Complete session example	38
9.3.2 Blocked timeslot scenario	39
9.3.3 Canceled timeslot scenario	40
9.3.4 Radio Timeslot extension example	41
<b>10 Bluetooth Low Energy protocol stack</b>	<b>43</b>
10.1 Profile and service support	43

10.2	<i>Bluetooth</i> Low Energy features . . . . .	45
10.3	Limitations on procedure concurrency . . . . .	50
10.4	<i>Bluetooth</i> Low Energy role configuration . . . . .	51
<b>11</b>	<b>Radio Notification</b> . . . . .	<b>53</b>
11.1	Radio Notification signals . . . . .	53
11.2	Radio Notification on connection events as a Central . . . . .	57
11.3	Radio Notification on connection events as a Peripheral . . . . .	59
11.4	Radio Notification with concurrent peripheral and central connection events . . . . .	60
11.5	Radio Notification with Connection Event Length Extension . . . . .	61
11.6	Power amplifier and low noise amplifier control configuration . . . . .	62
<b>12</b>	<b>Master boot record and bootloader</b> . . . . .	<b>63</b>
12.1	Master boot record . . . . .	63
12.2	Bootloader . . . . .	63
12.3	Master boot record and SoftDevice reset procedure . . . . .	64
12.4	Master boot record and SoftDevice initialization procedure . . . . .	65
<b>13</b>	<b>SoftDevice information structure</b> . . . . .	<b>66</b>
<b>14</b>	<b>SoftDevice memory usage</b> . . . . .	<b>67</b>
14.1	Memory resource map and usage . . . . .	67
14.1.1	Memory resource requirements . . . . .	68
14.2	Attribute table size . . . . .	69
14.3	Role configuration . . . . .	70
14.4	Security configuration . . . . .	70
14.5	Vendor specific UUID counts . . . . .	70
<b>15</b>	<b>Scheduling</b> . . . . .	<b>71</b>
15.1	SoftDevice timing-activities and priorities . . . . .	71
15.2	Initiator timing . . . . .	72
15.3	Connection timing as a Central . . . . .	74
15.4	Scanner timing . . . . .	76
15.4.1	Primary channel scanner timing . . . . .	76
15.4.2	Secondary channel scanner timing . . . . .	77
15.5	Advertiser timing . . . . .	78
15.6	Peripheral connection setup and connection timing . . . . .	79
15.7	Connection timing with Connection Event Length Extension . . . . .	80
15.8	Flash API timing . . . . .	81
15.9	Timeslot API timing . . . . .	81
15.10	Suggested intervals and windows . . . . .	81
<b>16</b>	<b>Interrupt model and processor availability</b> . . . . .	<b>85</b>
16.1	Exception model . . . . .	85
16.1.1	Interrupt forwarding to the application . . . . .	85
16.1.2	Interrupt latency due to System on Chip framework . . . . .	85
16.2	Interrupt priority levels . . . . .	86
16.3	Processor usage patterns and availability . . . . .	88
16.3.1	Flash API processor usage patterns . . . . .	88
16.3.2	Radio Timeslot API processor usage patterns . . . . .	89
16.3.3	<i>Bluetooth</i> Low Energy processor usage patterns . . . . .	90
16.3.4	Interrupt latency when using multiple modules and roles . . . . .	96

<b>17</b>	<b>Bluetooth Low Energy data throughput</b>	<b>97</b>
<b>18</b>	<b>Bluetooth Low Energy power profiles</b>	<b>101</b>
18.1	Advertising event	101
18.2	Peripheral connection event	102
18.3	Scanning event	103
18.4	Central connection event	104
<b>19</b>	<b>SoftDevice identification and revision scheme</b>	<b>106</b>
19.1	Master boot record distribution and revision scheme	107
	<b>Glossary</b>	<b>108</b>
	<b>Acronyms and abbreviations</b>	<b>111</b>
	<b>Legal notices</b>	<b>114</b>

# Revision history

Date	Version	Description
August 2018	6.1	<p>Updated for SoftDevice S132 version 6.1.0. Some additional corrections.</p> <p>Added:</p> <ul style="list-style-type: none"> <li>• Paragraph about extended RC calibration in <a href="#">Clock source</a> on page 19.</li> <li>• Paragraph about throughput calculations in <a href="#">Bluetooth Low Energy data throughput</a> on page 97.</li> <li>• Documentation related to LE Extended Advertising in: <ul style="list-style-type: none"> <li>• <a href="#">Flash memory API</a> on page 30.</li> <li>• <a href="#">Table 19: LL features in the Bluetooth Low Energy stack</a> on page 49.</li> <li>• <a href="#">Radio Notification</a> on page 53.</li> <li>• <a href="#">Scheduling</a> on page 71.</li> <li>• <a href="#">Bluetooth Low Energy power profiles</a> on page 101.</li> </ul> </li> <li>• <a href="#">Glossary</a>.</li> <li>• <a href="#">Acronyms and abbreviations</a> on page 111.</li> </ul> <p>Updated:</p> <ul style="list-style-type: none"> <li>• List of key features and applications in <a href="#">S132 SoftDevice</a> on page 11.</li> <li>• <a href="#">Programmable peripheral interconnect</a> on page 28 now references the hardware resource API instead of listing the PPI channel and group ranges.</li> <li>• PA pin timings in <a href="#">Power amplifier and low noise amplifier control configuration</a> on page 62.</li> <li>• <a href="#">Figure 22: MBR, SoftDevice, and bootloader architecture</a> on page 64 to align with the layout of the bootloader from nRF5 SDK.</li> <li>• Processor availability and interrupt processing time for all <i>Bluetooth</i> Low Energy roles in <a href="#">Bluetooth Low Energy processor usage patterns</a> on page 90.</li> </ul>
March 2018	6.0	<p>Updated for SoftDevice S132 version 6.0.0. Some additional corrections.</p> <p>Added:</p> <ul style="list-style-type: none"> <li>• Application control of MTU size, packet length, and PHY in <a href="#">Table 13: API features in the Bluetooth Low Energy stack</a> on page 46</li> <li>• Quality of Service and Channel map for Observer role in <a href="#">Table 20: Proprietary features in the Bluetooth Low Energy stack</a> on page 50</li> </ul> <p>Updated:</p> <ul style="list-style-type: none"> <li>• List of key features in <a href="#">S132 SoftDevice</a> on page 11.</li> </ul>

Date	Version	Description
		<ul style="list-style-type: none"> <li>• <a href="#">Profile and service support</a> on page 43. Updated the list of profiles and services currently adopted by the <i>Bluetooth</i> Special Interest Group.</li> <li>• <a href="#">Table 19: LL features in the Bluetooth Low Energy stack</a> on page 49.</li> <li>• <a href="#">Table 20: Proprietary features in the Bluetooth Low Energy stack</a> on page 50.</li> <li>• <a href="#">Bluetooth Low Energy role configuration</a> on page 51.</li> <li>• <a href="#">SoftDevice information structure</a> on page 66</li> <li>• <a href="#">SoftDevice memory usage</a> on page 67: The flash memory and minimum RAM requirements of the SoftDevice are no longer provided in this document. See the release notes for this information.</li> <li>• <a href="#">SoftDevice timing-activities and priorities</a> on page 71.</li> </ul>
December 2017	5.1	<p>Updated for SoftDevice S132 version 5.1.0. Some additional corrections.</p> <p>Updated:</p> <ul style="list-style-type: none"> <li>• <a href="#">Table 5: Allocation of software interrupt vectors to SoftDevice signals</a> on page 28. Two of the SWI priorities were changed in the S132 5.0.0 SoftDevice, but were not updated accordingly in the S132 SDS v5.0. S132 SDS v5.1 has the correct interrupt priorities for both the S132 5.1.0 and 5.0.0 SoftDevices.</li> <li>• <a href="#">SoftDevice memory usage</a> on page 67: Reduced SoftDevice RAM requirements.</li> <li>• Interrupt latency for open peripheral interrupt in <a href="#">Table 32: Additional latency due to SoftDevice and MBR forwarding interrupts</a> on page 86</li> <li>• Removed references to the Bandwidth Configuration API. This was removed from the SoftDevice in version 4.0.0.</li> <li>• <a href="#">Table 3: Hardware access type definitions</a> on page 25, <a href="#">Table 4: Peripheral protection and usage by SoftDevice</a> on page 25</li> </ul>
June 2017	5.0	<p>Updated for SoftDevice S132 version 5.0.0. The changes are mostly related to the added support for <i>Bluetooth</i> 5.0 features.</p> <p>Added:</p> <ul style="list-style-type: none"> <li>• <a href="#">Table 18: L2CAP features in the Bluetooth Low Energy stack</a> on page 48</li> </ul> <p>Updated:</p> <ul style="list-style-type: none"> <li>• <a href="#">Table 19: LL features in the Bluetooth Low Energy stack</a> on page 49</li> <li>• <a href="#">Suggested intervals and windows</a> on page 81</li> <li>• <a href="#">Table 39: Data throughput for a single connection with 23 byte ATT MTU</a> on page 97</li> <li>• <a href="#">Table 40: Data throughput for a single connection with 247 byte ATT MTU</a> on page 99</li> </ul>

Date	Version	Description
		<ul style="list-style-type: none"> <li>Bluetooth Low Energy power profiles on page 101</li> </ul>
May 2017	4.1	<p>Updated for SoftDevice S132 version 4.0.3</p> <p>Updated:</p> <ul style="list-style-type: none"> <li>Table 5: Allocation of software interrupt vectors to SoftDevice signals on page 28</li> <li>List of interrupt levels in Interrupt priority levels on page 86</li> <li>Figure 51: Exception model on page 87</li> <li>Typical processing time calculations in sections Bluetooth Low Energy Advertiser (Broadcaster) processor usage on page 90, Bluetooth Low Energy peripheral connection processor usage on page 91, Bluetooth Low Energy scanner and initiator processor usage on page 93, and Bluetooth Low Energy central connection processor usage on page 94</li> </ul>
March 2017	4.0	<p>Corresponding to SoftDevice S132 version 4.0.2. The updates are mostly related to notation changes, performance changes, and changes following the increased number of possible concurrent connections and the improved configuration of connections in S132 version 4.0.2.</p> <p>Updated:</p> <ul style="list-style-type: none"> <li>List of key features in S132 SoftDevice on page 11.</li> <li>Table 5: Allocation of software interrupt vectors to SoftDevice signals on page 28, Table 15: GATT features in the Bluetooth Low Energy stack on page 47, Table 19: LL features in the Bluetooth Low Energy stack on page 49, Table 22: Radio Notification notation and terminology on page 54, Table 23: Bluetooth Low Energy Radio Notification timing ranges on page 55, Table 30: Scheduling priorities on page 72, Table 31: Peripheral role timing ranges on page 80, Table 35: Processor usage when advertising on page 91, Table 36: Processor usage when connected on page 93, Table 37: Processor usage for scanning or initiating on page 94, Table 38: Processor usage latency when connected on page 96, Table 39: Data throughput for a single connection with 23 byte ATT MTU on page 97, Table 40: Data throughput for a single connection with 247 byte ATT MTU on page 99, Table 41: Data throughput for up to 8 connections on page 100,</li> <li>Section Bluetooth Low Energy role configuration on page 51.</li> <li>Notation for timing constants in text and figures in Radio Notification on page 53 and Scheduling on page 71.</li> <li>Section Role configuration on page 70.</li> <li>Section SoftDevice timing-activities and priorities on page 71.</li> <li>Section Connection timing as a Central on page 74.</li> </ul>

Date	Version	Description
		<ul style="list-style-type: none"> <li>Section <a href="#">Suggested intervals and windows</a> on page 81.</li> </ul>
December 2016	3.1	<p>Corresponding to SoftDevice S132 versions 3.0.0 and 3.1.0.</p> <p>Updated:</p> <ul style="list-style-type: none"> <li>Events - SoftDevice to Application Section in <a href="#">Events - SoftDevice to application</a> on page 17.</li> <li><a href="#">Table 3: Hardware access type definitions</a> on page 25, <a href="#">Table 4: Peripheral protection and usage by SoftDevice</a> on page 25, and <a href="#">Table 5: Allocation of software interrupt vectors to SoftDevice signals</a> on page 28.</li> <li>Section <a href="#">Advertiser timing</a> on page 78.</li> <li>Figures of SoftDevice interrupt priority levels and processor usage patterns in <a href="#">Interrupt model and processor availability</a> on page 85.</li> <li>Introductory text in <a href="#">Bluetooth Low Energy data throughput</a> on page 97.</li> </ul> <p>Added:</p> <ul style="list-style-type: none"> <li>Section <a href="#">High-frequency clock configuration</a> on page 34.</li> </ul>
August 2016	3.0	<p>Corresponding to SoftDevice S132 version 3.0.0.</p> <p>Updated:</p> <ul style="list-style-type: none"> <li>List of key features in <a href="#">S132 SoftDevice</a> on page 11.</li> <li><a href="#">Bluetooth Low Energy protocol stack</a> on page 43, adding: <ul style="list-style-type: none"> <li>MTU exchange procedure and Write long characteristic values in <a href="#">Table 15: GATT features in the Bluetooth Low Energy stack</a> on page 47.</li> <li>Numeric comparison in <a href="#">Table 16: SM features in the Bluetooth Low Energy stack</a> on page 48.</li> <li>Configurable ATT_MTU size in <a href="#">Table 17: ATT features in the Bluetooth Low Energy stack</a> on page 48.</li> <li>Data packet length extension, LE Ping, Privacy, and Extended scanner filter policies in <a href="#">Table 19: LL features in the Bluetooth Low Energy stack</a> on page 49.</li> </ul> </li> <li><a href="#">Radio Notification signals</a> on page 53 with an additional section on Radio Notification with Connection Event Length Extension.</li> <li><a href="#">SoftDevice information structure</a> on page 66.</li> <li><a href="#">SoftDevice memory usage</a> on page 67: updated SoftDevice flash memory and RAM requirements.</li> <li><a href="#">Scheduling</a> on page 71 with an additional section on connection timing with Connection Event Length Extension, <a href="#">Connection timing with Connection Event Length Extension</a> on page 80.</li> <li><a href="#">Bluetooth Low Energy data throughput</a> on page 97: <ul style="list-style-type: none"> <li>Updated figures of SoftDevice data throughput for single link on <a href="#">Table 39: Data throughput for a single connection with 23 byte ATT MTU</a> on page 97,</li> </ul> </li> </ul>



Date	Version	Description
		<ul style="list-style-type: none"> <li>Added table for maximum achievable single-link throughput: <a href="#">Table 39: Data throughput for a single connection with 23 byte ATT MTU</a> on page 97.</li> </ul>
April 2016	2.0	<p>Corresponding to SoftDevice S132 version 2.0.0. The SDS revision 1.0 is intentionally skipped to align with the SoftDevice version and with the S130 SDS version.</p> <p>Updated:</p> <ul style="list-style-type: none"> <li><a href="#">SoftDevice Manager</a> on page 19. Added documentation on (previously in Appendix A): <ul style="list-style-type: none"> <li>Clock source</li> <li>Power management</li> <li>Memory isolation and runtime protection</li> </ul> </li> <li><a href="#">Hardware peripherals</a> on page 25.</li> <li><a href="#">Programmable peripheral interconnect</a> on page 28. Documented PPI channel changes.</li> <li><a href="#">Flash memory API</a> on page 30. Documented changes and new numbers.</li> <li><a href="#">Profile and service support</a> on page 43. Updated the list of profiles and services currently adopted by the <i>Bluetooth</i> Special Interest Group.</li> <li><a href="#">Radio Notification</a> on page 53.</li> <li><a href="#">Master boot record</a> on page 63.</li> <li><a href="#">Scheduling</a> on page 71 (previously Chapter 14: Multilink scheduling).</li> <li><a href="#">Interrupt model and processor availability</a> on page 85. Updated section to align with the new SoftDevice priority level structure.</li> <li><a href="#">Bluetooth Low Energy data throughput</a> on page 97. Updated documentation with new numbers.</li> </ul> <p>Added:</p> <ul style="list-style-type: none"> <li><a href="#">Application programming interface</a> on page 17 (previously in Appendix A). Now also including section <a href="#">Error handling</a> on page 17.</li> <li><a href="#">Bluetooth Low Energy role configuration</a> on page 51.</li> <li><a href="#">Power amplifier and low noise amplifier control configuration</a> on page 62.</li> <li><a href="#">SoftDevice memory usage</a> on page 67 (<a href="#">Memory resource map and usage</a> on page 67 and <a href="#">Attribute table size</a> on page 69 previously in Chapter 13: System on Chip resource requirements; Call Stack and Heap information previously in Appendix A can be found under <a href="#">Memory resource requirements</a> on page 68).</li> <li><a href="#">SoftDevice timing-activities and priorities</a> on page 71.</li> <li><a href="#">Timeslot API timing</a> on page 81.</li> </ul> <p>Several chapters have been restructured, relocated and revised. Appendix A is removed.</p>

---

Date	Version	Description
June 2015	0.5	Preliminary release.

# 1 S132 SoftDevice

The S132 SoftDevice is a *Bluetooth* Low Energy Central and Peripheral protocol stack solution. It supports up to twenty connections with an additional observer and a broadcaster role all running concurrently. The S132 SoftDevice integrates a *Bluetooth* Low Energy Controller and Host, and provides a full and flexible API for building *Bluetooth* Low Energy nRF52 System on Chip solutions.

Key features	Applications
<ul style="list-style-type: none"> <li>• <i>Bluetooth</i> 5 compliant single-mode <i>Bluetooth</i> Low Energy protocol stack</li> <li>• Concurrent central, observer, peripheral, and broadcaster roles with up to 20 concurrent connections along with one Observer and one Broadcaster</li> <li>• Extended Advertising support <ul style="list-style-type: none"> <li>• Advertising and scanning up to 255 bytes of advertising data in an advertising event</li> <li>• Advertising, scanning, and connecting on all supported PHYs</li> <li>• Anonymous advertising</li> </ul> </li> <li>• Configurable number of connections and connection properties</li> <li>• Configurable attribute table size</li> <li>• Custom UUID support</li> <li>• Link layer supporting LE 1M PHY and LE 2M PHY</li> <li>• LL Privacy, including for the Extended Advertising modes</li> <li>• LE Data Packet Length Extension</li> <li>• ATT and SM protocols</li> <li>• L2CAP with LE Credit-based Flow Control</li> <li>• LE Secure Connections pairing model</li> <li>• GATT and GAP APIs</li> <li>• GATT Client and Server</li> <li>• Configurable ATT MTU</li> <li>• Complementary nRF5 SDK including <i>Bluetooth</i> profiles and example applications</li> <li>• Master Boot Record for over-the-air device firmware update <ul style="list-style-type: none"> <li>• SoftDevice, application, and bootloader can be updated separately</li> </ul> </li> <li>• Memory isolation between the application and the protocol stack for robustness and security</li> <li>• Thread-safe supervisor-call based API</li> <li>• Asynchronous, event-driven behavior</li> <li>• No RTOS dependency <ul style="list-style-type: none"> <li>• Any RTOS can be used</li> </ul> </li> <li>• No link-time dependencies <ul style="list-style-type: none"> <li>• Standard ARM<sup>®</sup> Cortex<sup>®</sup>-M4 project configuration for application development</li> </ul> </li> <li>• Support for concurrent and non-concurrent multiprotocol operation <ul style="list-style-type: none"> <li>• Concurrent with the <i>Bluetooth</i> stack using Radio Timeslot API</li> <li>• Alternate protocol stack in application space</li> </ul> </li> </ul>	<ul style="list-style-type: none"> <li>• Sports and fitness devices <ul style="list-style-type: none"> <li>• Sports watches</li> <li>• Bike computers</li> <li>• Fitness machines</li> </ul> </li> <li>• Personal area networks <ul style="list-style-type: none"> <li>• Health and fitness sensor and monitoring devices</li> <li>• Medical devices</li> <li>• Key fobs and wrist watches</li> </ul> </li> <li>• Home automation</li> <li>• AirFuel wireless charging</li> <li>• Remote control toys</li> <li>• Computer peripherals and I/O devices <ul style="list-style-type: none"> <li>• Mice</li> <li>• Keyboards</li> <li>• Multi-touch trackpads</li> </ul> </li> <li>• Interactive entertainment devices <ul style="list-style-type: none"> <li>• Remote controls</li> <li>• Gaming controllers</li> </ul> </li> </ul>

Key features	Applications
<ul style="list-style-type: none"><li>• Support for control of external power amplifiers and low noise amplifiers</li><li>• Quality of service module with channel noise monitoring</li></ul>	

# 2 Documentation

Additional recommended reading for developing applications using the SoftDevice on the nRF52 *SoC* includes the product specification, errata, compatibility matrix, and *Bluetooth* Core Specification.

A list of the recommended documentation for the SoftDevice is given in the following table.

Documentation	Description
nRF52832 Product Specification	Contains a description of the hardware, peripherals, and electrical specifications specific to the nRF52832 <i>Integrated Circuit (IC)</i>
nRF52832 Errata	Contains information on anomalies related to the nRF52832 <i>IC</i>
nRF52832 Compatibility Matrix	Contains information on the compatibility between nRF52832 <i>IC</i> revisions, SoftDevices and SoftDevice Specifications, <i>Software Development Kit (SDK)</i> s, development kits, documentation, and <i>Qualified Design Identification (QDID)</i> s
Bluetooth Core Specification	The <i>Bluetooth</i> Core Specification version 5.0, Volumes 1, 3, 4, and 6, describe <i>Bluetooth</i> terminology which is used throughout the SoftDevice Specification.

Table 1: S132 SoftDevice core documentation

# 3 Product overview

The S132 SoftDevice is a precompiled and linked binary image implementing a *Bluetooth* 5 Low Energy protocol stack for the nRF52 Series of *SoCs*.

See the [nRF52832 Compatibility Matrix](#) for SoftDevice/*IC* compatibility information.

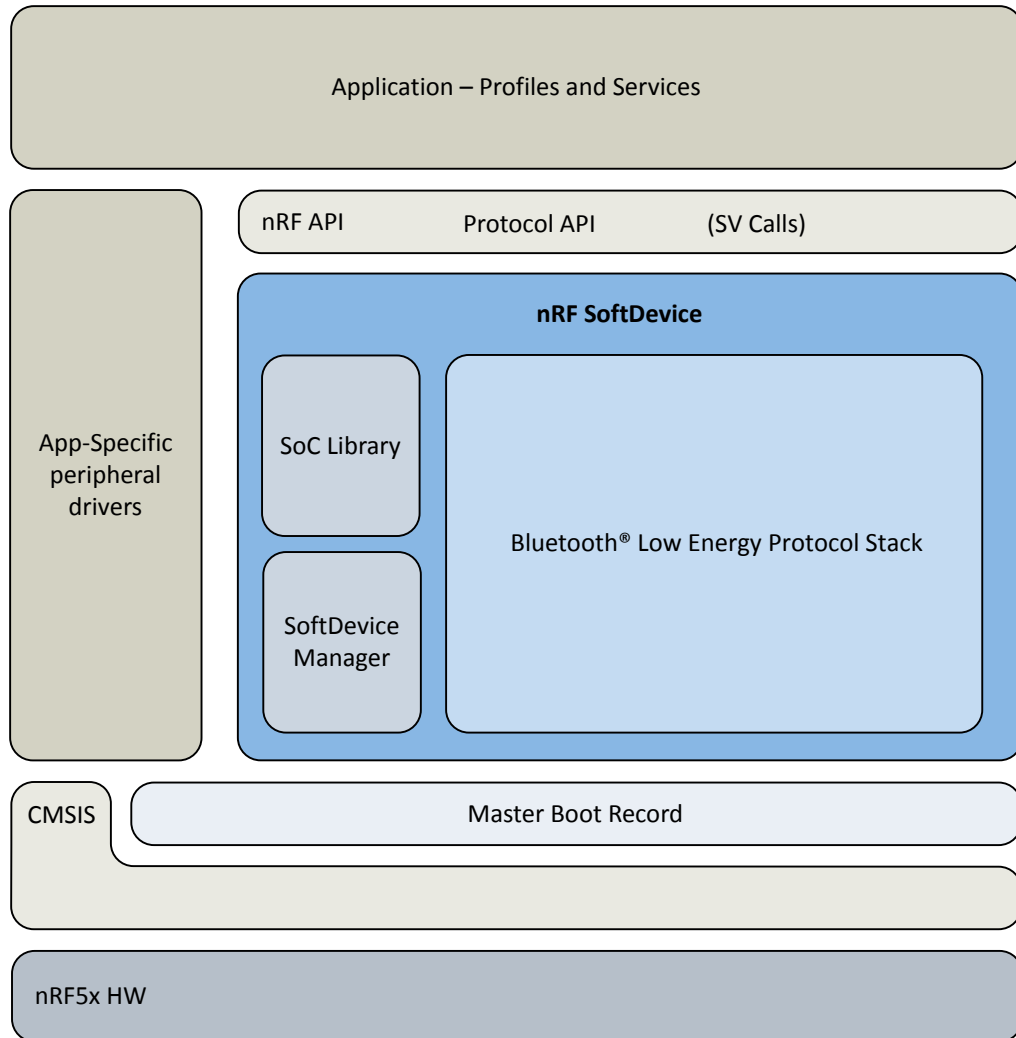

Figure 1: SoC application with the SoftDevice

Figure 1: SoC application with the SoftDevice on page 15 shows the nRF52 series software architecture. It includes the standard ARM *Cortex Microcontroller Software Interface Standard (CMSIS)* interface for nRF52 hardware, the MBR, profile and application code, application specific peripheral drivers, and a firmware module identified as a SoftDevice.

A SoftDevice consists of three main components:

- *SoC* Library: implementation and nRF *API* for shared hardware resource management (application coexistence)
- *SDM*: implementation and nRF *API* for SoftDevice management (enabling/disabling the SoftDevice, etc.)
- *Bluetooth* 5 Low Energy protocol stack: implementation of protocol stack and *API*

The *API* is a set of standard C language functions and data types provided as a series of header files that give the application complete compiler and linker independence from the SoftDevice implementation. For more information, see [Application programming interface](#) on page 17.

The SoftDevice enables the application developer to develop their code as a standard ARM Cortex -M4 project without having the need to integrate with proprietary *IC* vendor software frameworks. This means that any ARM Cortex -M4-compatible toolchain can be used to develop *Bluetooth* Low Energy applications with the SoftDevice.

The SoftDevice can be programmed onto compatible nRF52 Series *ICs* during both development and production.



# 4 Application programming interface

The SoftDevice *API* is available to applications as a C programming language interface based on *SVCs* and defined in a set of header files.

All variants of SoftDevices with the same version number are *API* compatible. In addition to a Protocol *API* enabling wireless applications, there is an nRF *API* that exposes the functionality of both the *SDM* and the *SoC* library.

**Note:** When the SoftDevice is disabled, only a subset of the SoftDevice *APIs* is available to the application (see [S132 SoftDevice API](#)). For more information about enabling and disabling the SoftDevice, see [SoftDevice enable and disable](#) on page 19.

*SVCs* are software triggered interrupts conforming to a procedure call standard for parameter passing and return values. Each SoftDevice *API* call triggers a *SVC* interrupt. The SoftDevice *SVC* interrupt handler locates the correct SoftDevice function, allowing applications to compile without any *API* function address information at compile time. This removes the need for the application to link the SoftDevice. The header files contain all information required for the application to invoke the *API* functions with standard programming language prototypes. This *SVC* interface makes SoftDevice *API* calls thread-safe: they can be invoked from the application's different priority levels without additional synchronization mechanisms.

**Note:** SoftDevice *API* functions can only be called from a lower interrupt priority level (higher numerical value for the priority level) than the *SVC* priority. For more information, see [Interrupt priority levels](#) on page 86.

## 4.1 Events - SoftDevice to application

Software triggered interrupts in a reserved IRQ are used to signal events from the SoftDevice to the application. The application is then responsible for handling the interrupt and for invoking the relevant SoftDevice functions to obtain the event data.

The application must respond to and process the SoftDevice events to ensure the SoftDevice functions properly. If events for *Bluetooth* Low Energy control procedures are not serviced, the procedures may time out and result in a link disconnection. If data received by the SoftDevice from the peer is not fetched in time, the internal SoftDevice data buffers may become full and no more data can be received.

For further details on how to implement the handling of these events, see the nRF5 Software Development Kit ([nRF5 SDK](#)) documentation.

## 4.2 Error handling

All SoftDevice *API* functions return a 32-bit error code. The application must check this error code to confirm whether a SoftDevice *API* function call was successful.

Unrecoverable failures (faults) detected by the SoftDevice will be reported to the application by a registered, fault handling callback function. A pointer to the fault handler must be provided by the application upon SoftDevice initialization. The fault handler is then used to notify of unrecoverable errors, and the type of error is indicated as a parameter to the fault handler.

The following types of faults can be reported to the application through the fault handler:

- SoftDevice assertions

- Attempts by the application to perform unallowed memory accesses, either against SoftDevice memory protection rules or to protected peripheral configuration registers at runtime

The fault handler callback is invoked by the SoftDevice in HardFault context with all interrupts disabled.

# 5 SoftDevice Manager

The *SDM API* allows the application to manage the SoftDevice on a top level. It controls the SoftDevice state and configures the behavior of certain SoftDevice core functionality.

When enabling the SoftDevice, the *SDM* configures the following:

- The LFCLK source. See [Clock source](#) on page 19.
- The interrupt management. See [SoftDevice enable and disable](#) on page 19.
- The embedded protocol stack.

In addition, it enables the SoftDevice RAM and peripheral protection. See [Memory isolation and runtime protection](#) on page 20.

Detailed documentation of the *SDM API* is made available with the *SDKs*.

## 5.1 SoftDevice enable and disable

When the SoftDevice is not enabled, the Protocol *API* and parts of the *SoC* library *API* are not available to the application.

When the SoftDevice is not enabled, most of the *SoC*'s resources are available to the application. However, the following restrictions apply:

- *SVC* numbers 0x10 to 0xFF are reserved.
- SoftDevice program (flash) memory is reserved.
- A few bytes of RAM are reserved. See [Memory resource map and usage](#) on page 67 for more details.

Once the SoftDevice has been enabled, more restrictions apply:

- Some RAM will be reserved. See [Memory isolation and runtime protection](#) on page 20 for more details.
- Some peripherals will be reserved. See [Hardware peripherals](#) on page 25 for more details.
- Some of the peripherals that are reserved will have a *SoC* library interface.
- Interrupts from the reserved SoftDevice peripherals will not be forwarded to the application. See [Interrupt forwarding to the application](#) on page 85 for more details.
- The reserved peripherals are reset upon SoftDevice disable.
- `nrf_nvic_` functions must be used instead of *CMSIS* `NVIC_` functions for safe use of the SoftDevice.
- SoftDevice activity in high priority levels may interrupt the application, increasing the maximum interrupt latency. For more information, see [Interrupt model and processor availability](#) on page 85.

## 5.2 Clock source

The SoftDevice can use one of two available LFCLK sources: the internal RC Oscillator, or external Crystal Oscillator.

The application must provide the selected clock source and some clock source characteristics, such as accuracy, when it enables the SoftDevice. The *SDM* is responsible for configuring the LFCLK source and for keeping it calibrated when the RC oscillator is the selected clock source.

If the SoftDevice is configured with the internal RC oscillator clock option, periodic clock calibration is required to adjust the RC oscillator frequency. Additional calibration is required for temperature changes

of more than 0.5°C. See the relevant product specification ([Table 1: S132 SoftDevice core documentation](#) on page 14) for more information. The SoftDevice will perform this function automatically. The application may choose how often the SoftDevice will make a measurement to detect temperature change. The application must consider how frequently significant temperature changes are expected to occur in the intended environment of the end product. It is recommended to use a temperature polling interval of 4 seconds, and to force clock calibration every second interval (`.rc_ctiv=16, .rc_temp_ctiv=2`).

Extended RC calibration is enabled by default when the RC oscillator is used. In this feature, the SoftDevice as a peripheral can detect if the clock has drifted and then calibrate the RC oscillator if necessary. This calibration is in addition to the periodic calibration. If using only peripheral connections, the periodic calibration can then be configured with a much longer interval as the peripheral will be able to detect and adjust automatically to clock drift and calibrate when required. When the Extended RC calibration is enabled, the SoftDevice as a peripheral will try to increase the receive window if two consecutive packets are not received. If it turns out that the packets were missed due to clock drift, the RC oscillator calibration is started. Extended RC calibration can be disabled using the BLE option API.

## 5.3 Power management

The SoftDevice implements a simple to use SoftDevice Power API for optimized power management.

The application must use this [API](#) when the SoftDevice is enabled to ensure correct function. When the SoftDevice is disabled, the application must use the hardware abstraction ([CMSIS](#)) interfaces for power management directly.

When waiting for application events using the [API](#), the CPU goes to an IDLE state whenever the SoftDevice is not using the CPU, and interrupts handled directly by the SoftDevice do not wake the application. Application interrupts will wake the application as expected. When going to system OFF, the [API](#) ensures the SoftDevice services are stopped before powering down.

## 5.4 Memory isolation and runtime protection

The SoftDevice data memory and peripherals can be sandboxed and runtime protected to prevent the application from interfering with the SoftDevice execution, ensuring robust and predictable performance.

Sandboxing<sup>1</sup> and runtime protection can allow memory access violations to be detected at development time. This ensures that developed applications will not inadvertently interfere with the correct functioning of the SoftDevice.

Sandboxing is enabled by default when the SoftDevice is enabled, and disabled when the SoftDevice is disabled. When enabled, SoftDevice RAM and peripheral registers are protected against write access by the application. The application will have read access to SoftDevice RAM and peripheral registers.

The program memory is divided into two regions at compile time. The SoftDevice Flash Region is located between addresses 0x00000000 and `APP_CODE_BASE - 1` and is occupied by the SoftDevice. The Application Flash Region is located between the addresses `APP_CODE_BASE` and the last valid address in the flash memory and is available to the application.

The RAM is split into two regions, which are defined at runtime, when the SoftDevice is enabled. The SoftDevice RAM Region is located between the addresses 0x20000000 and `APP_RAM_BASE - 1` and is used by the SoftDevice. The Application RAM Region is located between the addresses `APP_RAM_BASE` and the top of RAM and is available to the application.

The following figure presents an overview of the regions.

<sup>1</sup> A sandbox is a set of memory access restrictions imposed on the application.

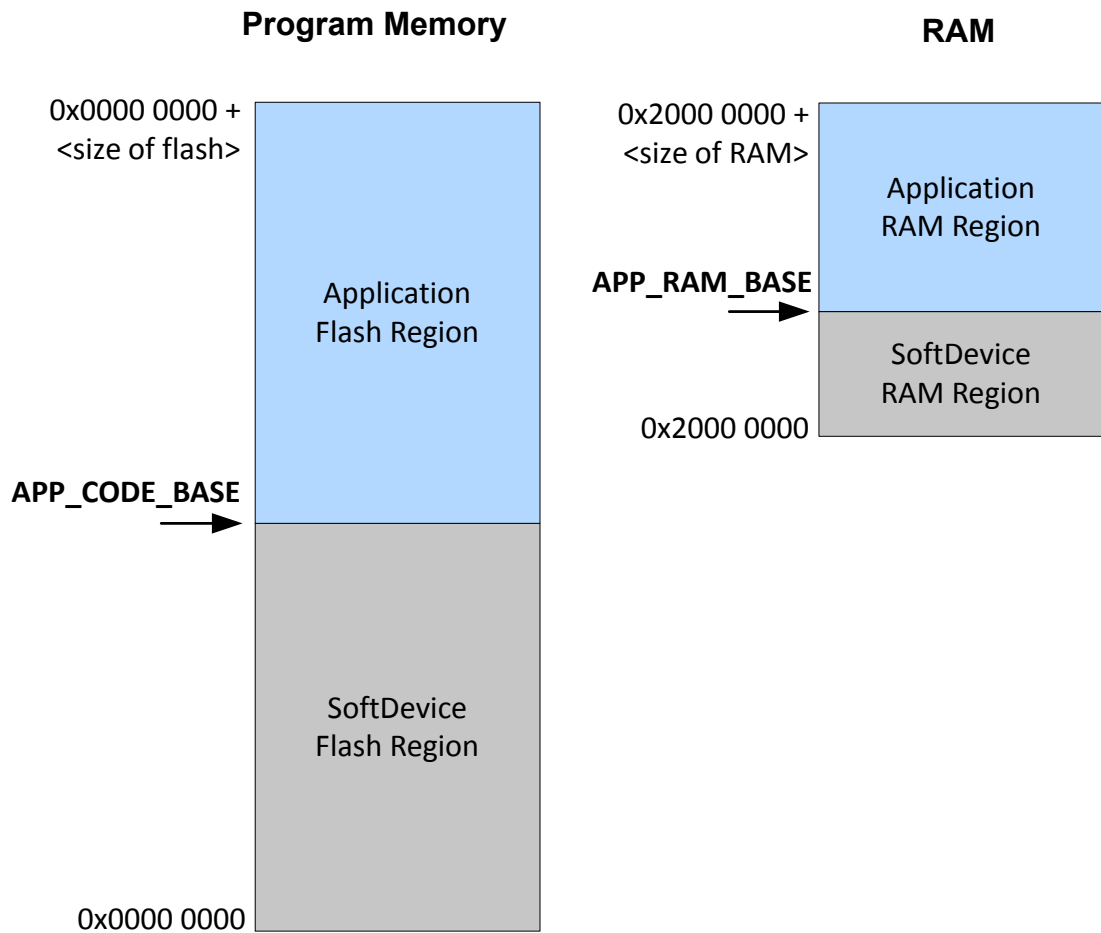

Figure 2: Memory region designation

The SoftDevice uses a fixed amount of flash (program) memory. By contrast, the size of the SoftDevice RAM Region depends on whether the SoftDevice is enabled or not, and on the selected *Bluetooth* Low Energy protocol stack configuration. See [Role configuration](#) on page 70 for more details.

The amount of flash and RAM available to the application is determined by region size (kilobytes or bytes) and the `APP_CODE_BASE` and `APP_RAM_BASE` addresses which are the base addresses of the application code and RAM, respectively. The application code must be located between `APP_CODE_BASE` and `<size of flash>`. The application variables must be allocated in an area inside the Application RAM Region, located between `APP_RAM_BASE` and `<size of RAM>`. This area shall not overlap with the allocated RAM space for the call stack and heap, which is also located inside the Application RAM Region.

The program code address range of an example application:

$$\text{APP\_CODE\_BASE} \leq \text{Program} \leq \text{<size of flash>}$$

RAM address range of example application assuming call stack and heap location as shown in [Figure 24: Memory resource map](#) on page 68:

$$\text{APP\_RAM\_BASE} \leq \text{RAM} \leq (0x2000\ 0000 + \text{<size of RAM>}) - (\text{<Call Stack>} + \text{<Heap>})$$

Sandboxing protects the SoftDevice RAM Region so that it cannot be written to by the application at runtime. Violation of sandboxing rules, for example, an attempt to write to the protected SoftDevice memory, will result in the triggering of a fault (unrecoverable error handled by the application). See [Error handling](#) on page 17 for more information.

When the SoftDevice is disabled, all RAM, with the exception of a few bytes, is available to the application. See [Memory resource map and usage](#) on page 67 for more details. When the SoftDevice is enabled, RAM up to `APP_RAM_BASE` will be used by the SoftDevice and will be write protected.

The typical location of the call stack for an application using the SoftDevice is in the upper part of the Application RAM Region, so the application can place its variables from the end of the SoftDevice RAM Region (`APP_RAM_BASE`) to the beginning of the call stack space.

**Note:**

- The location of the call stack is communicated to the SoftDevice through the contents of the *Main Stack Pointer (MSP)* register.
- Do not change the value of *MSP* dynamically (i.e. never set the *MSP* register directly).
- The RAM located in the SoftDevice RAM Region will be overwritten once the SoftDevice is enabled.
- The SoftDevice RAM Region will not be cleared or restored to default values after disabling the SoftDevice, so the application must treat the contents of the region as uninitialized memory.

# 6 System on Chip library

The coexistence of the Application and SoftDevice with safe sharing of common *SoC* resources is ensured by the *SoC* library.

The features described in the following table are implemented by the *SoC* library and can be used for accessing the shared hardware resources when the SoftDevice is enabled.

Feature	Description
Mutex	The SoftDevice implements atomic mutex acquire and release operations that are safe for the application to use. Use this mutex to avoid disabling global interrupts in the application, because disabling global interrupts will interfere with the SoftDevice and may lead to dropped packets or lost connections.
NVIC	Wrapper functions for the <i>CMSIS</i> NVIC functions provided by ARM.  <b>Note:</b> To ensure reliable usage of the SoftDevice you must use the wrapper functions when the SoftDevice is enabled.
Rand	Provides random numbers from the hardware random number generator.
Power	Access to POWER block configuration: <ul style="list-style-type: none"> <li>• Access to RESETREAS register</li> <li>• Set power modes</li> <li>• Configure power fail comparator</li> <li>• Control RAM block power</li> <li>• Use general purpose retention register</li> <li>• Configure DC/DC converter state: <ul style="list-style-type: none"> <li>• DISABLED</li> <li>• ENABLED</li> </ul> </li> </ul>
Clock	Access to CLOCK block configuration. Allows the HFCLK Crystal Oscillator source to be requested by the application.
Wait for event	Simple power management call for the application to use to enter a sleep or idle state and wait for an application event.
PPI	Configuration interface for <i>PPI</i> channels and groups reserved for an application. <sup>2</sup>
Radio Timeslot API	Schedule other radio protocol activity, or periods of radio inactivity. For more information, see <a href="#">Concurrent multiprotocol implementation using the Radio Timeslot API</a> on page 33.
Radio Notification	Configure Radio Notification signals on ACTIVE and/or nACTIVE. See <a href="#">Radio Notification signals</a> on page 53.
Block Encrypt (ECB)	Safe use of 128-bit AES encrypt HW accelerator
Event API	Fetch asynchronous events generated by the <i>SoC</i> library.

Feature	Description
Flash memory API	Application access to flash write, erase, and protect. Can be safely used during all protocol stack states. <sup>2</sup> See <a href="#">Flash memory API</a> on page 30.
Temperature	Application access to the temperature sensor

*Table 2: SoC features*

---

<sup>2</sup> This can also be used when the SoftDevice is disabled.



# 7 System on Chip resource requirements

This section describes how the SoftDevice, including the MBR, uses the *SoC* resources. The SoftDevice requirements are shown for when the SoftDevice is enabled and disabled.

The SoftDevice and MBR (see [Master boot record and bootloader](#) on page 63) are designed to be installed on the nRF *SoC* in the lower part of the code memory space. After a reset, the MBR will use some RAM to store state information. When the SoftDevice is enabled, it uses resources on the *SoC* including RAM and hardware peripherals like the radio. For the amount of RAM required by the SoftDevice, see [SoftDevice memory usage](#) on page 67.

## 7.1 Hardware peripherals

SoftDevice access types are used to indicate the availability of hardware peripherals to the application. The availability varies per hardware peripheral and depends on whether the SoftDevice is enabled or disabled.

Access type	Definition
Restricted	The hardware peripheral is used by the SoftDevice and is outside the application sandbox. When the SoftDevice is enabled, it shall only be accessed through the SoftDevice API. Through this <i>API</i> , the application has limited access.
Blocked	The hardware peripheral is used by the SoftDevice and is outside the application sandbox.  The application has no access. Interrupts from blocked peripherals are forwarded to the SoftDevice by the MBR and are not available to the application, even inside a Radio Timeslot API timeslot.
Open	The hardware peripheral is not used by the SoftDevice.  The application has full access.

Table 3: Hardware access type definitions

ID	Base address	Instance	Access SoftDevice enabled	Access SoftDevice disabled
0	0x40000000	CLOCK	Restricted	Open
0	0x40000000	POWER	Restricted	Open
0	0x40000000	BPROT	Restricted	Open
1	0x40001000	RADIO	Blocked <sup>6</sup>	Open

ID	Base address	Instance	Access	
			SoftDevice enabled	SoftDevice disabled
2	0x40002000	UARTE0	Open	Open
3	0x40003000	TWIM0/TWIS0/ SPIM0/SPIS0	Open	Open
4	0x40004000	TWIS1/SPIM1/ TWIM1/SPIS1	Open	Open
...				
6	0x40006000	GPIOTE	Open	Open
7	0x40007000	SAADC	Open	Open
8	0x40008000	TIMER0	Blocked <sup>6</sup>	Open
9	0x40009000	TIMER1	Open	Open
10	0x4000A000	TIMER2	Open	Open
11	0x4000B000	RTC0	Blocked	Open
12	0x4000C000	TEMP	Restricted	Open
13	0x4000D000	RNG	Restricted	Open
14	0x4000E000	ECB	Restricted	Open
15	0x4000F000	CCM	Blocked <sup>7</sup>	Open
15	0x4000F000	AAR	Blocked <sup>7</sup>	Open
16	0x40010000	WDT	Open	Open
17	0x40011000	RTC1	Open	Open
18	0x40012000	QDEC	Open	Open
19	0x40013000	LPCOMP/COMP	Open	Open
20	0x40014000	EGU0/SWI0	Open	Open
21	0x40015000	EGU1/SWI1/ Radio Notification	Restricted <sup>8</sup>	Open
22	0x40016000	EGU2/SWI2/ SoftDevice Event	Open <sup>9</sup>	Open
23	0x40017000	EGU3/SWI3	Open	Open
24	0x40018000	EGU4/SWI4	Open	Open
25	0x40019000	EGU5/SWI5	Blocked	Open
...				
26	0x4001A000	TIMER3	Open	Open
27	0x4001B000	TIMER4	Open	Open
28	0x4001C000	PWM0	Open	Open

ID	Base address	Instance	Access	Access
			SoftDevice enabled	SoftDevice disabled
29	0x4001D000	PDM	Open	Open
30	0x4001E000	NVMC	Restricted	Open
31	0x4001F000	PPI	Open <sup>3</sup>	Open
32	0x40020000	MWU	Restricted <sup>4</sup>	Open
33	0x40021000	PWM1	Open	Open
34	0x40022000	PWM2	Open	Open
35	0x40023000	SPIS2/SPIM2	Open	Open
36	0x40024000	RTC2	Open	Open
37	0x40025000	I2S	Open	Open
38	0x40026000	FPU	Open	Open
NA	0x10000000	FICR	Blocked	Blocked
NA	0x10001000	UICR	Restricted	Open
NA	0x50000000	GPIO P0	Open	Open
NA	0xE000E100	NVIC	Restricted <sup>5</sup>	Open

Table 4: Peripheral protection and usage by SoftDevice

## 7.2 Application signals – software interrupts

Software interrupts are used by the SoftDevice to signal events to the application.

<sup>3</sup> See section [Programmable peripheral interconnect](#) on page 28 for limitations on the use of PPI when the SoftDevice is enabled.

<sup>4</sup> See section [Memory isolation and runtime protection](#) on page 20 and [Peripheral runtime protection](#) on page 29 for limitations on the use of MWU when the SoftDevice is enabled.

<sup>5</sup> Not protected. For robust system function, the application program must comply with the restriction and use the NVIC API for configuration when the SoftDevice is enabled.

<sup>6</sup> The peripheral is available to the application through the Radio Timeslot API. See [Concurrent multiprotocol implementation using the Radio Timeslot API](#) on page 33. When inside a timeslot, interrupts from these peripherals are forwarded to the application through the application provided callback functions.

<sup>7</sup> The peripheral is available to the application during a Radio Timeslot API timeslot. See [Concurrent multiprotocol implementation using the Radio Timeslot API](#) on page 33.

<sup>8</sup> Blocked only when Radio Notification signal is enabled. See [Application signals – software interrupts](#) on page 27 for SWI allocation.

<sup>9</sup> Interrupt will be set to pending state by the SoftDevice on SoftDevice Event Notification, but the application may also set it to pending state.

SWI	Peripheral ID	Interrupt priority	SoftDevice Signal
0	20	-	Unused by the SoftDevice and available to the application
1	21	6	Radio Notification. The interrupt priority can optionally be configured through the SoftDevice NVIC API.
2	22	6	SoftDevice Event Notification. The interrupt priority can optionally be configured through the SoftDevice NVIC API.
3	23	-	Unused by the SoftDevice and available to the application
4	24	-	Reserved for future use
5	25	4	SoftDevice processing - not user configurable

Table 5: Allocation of software interrupt vectors to SoftDevice signals

## 7.3 Programmable peripheral interconnect

A set of *PPI* channels and groups may be configured using the *PPI API* in the *SoC* library.

This *API* is available both when the SoftDevice is disabled and when it is enabled. It is also possible to configure the *PPIs* using the *CMSIS* directly when the SoftDevice is disabled.

When the SoftDevice is disabled, all *PPI* channels and groups are available to the application.

When the SoftDevice is enabled, some of the *PPI* channels and groups are reserved by the SoftDevice. The application must therefore not change the configuration of these *PPI* channels or groups when the SoftDevice is enabled. Failing to comply with this will cause the SoftDevice to not operate properly.

The *PPI* channels and groups that are reserved by the SoftDevice when enabled are defined in `nrf_soc.h`.

## 7.4 SVC number ranges

Application programs and SoftDevices use certain *SVC* numbers.

The table below shows which *SVC* numbers an application program can use and which numbers are used by the SoftDevice.

**Note:** The *SVC* number allocation does not change with the state of the SoftDevice (enabled or disabled).

SVC number allocation	SoftDevice enabled	SoftDevice disabled
Application	0x00-0x0F	0x00-0x0F
SoftDevice	0x10-0xFF	0x10-0xFF

Table 6: SVC number allocation

## 7.5 Peripheral runtime protection

To prevent the application from accidentally disrupting the protocol stack in any way, the application sandbox also protects the peripherals used by the SoftDevice.

Protected peripheral registers are readable by the application. An attempt to perform a write to a protected peripheral register will result in a Hard Fault. See [Error handling](#) on page 17 for more details on faults due to unallowed memory access. The peripherals are only protected when the SoftDevice is enabled; otherwise, they are available to the application. See [Table 4: Peripheral protection and usage by SoftDevice](#) on page 25 for an overview of the peripherals with access restrictions due to the SoftDevice.

## 7.6 External and miscellaneous requirements

For correct operation of the SoftDevice, it is a requirement that the crystal oscillator (HFXO) startup time is less than 1.5 ms.

The external clock crystal and other related components must be chosen accordingly. Data for the crystal oscillator input can be found in the relevant *SoC* product specification ([Table 1: S132 SoftDevice core documentation](#) on page 14).

When the SoftDevice is enabled, the SEVONPEND flag in the SCR register of the CPU shall only be changed from main or low interrupt level (priority not higher than 4). Otherwise, the behavior of the SoftDevice is undefined and the SoftDevice might malfunction.

# 8 Flash memory API

The *SoC* flash memory *API* provides the application with flash write, flash erase, and flash protect support through the SoftDevice. Asynchronous flash memory operations can be safely performed during active *Bluetooth* Low Energy connections using the Flash memory *API* of the *SoC* library.

The flash memory accesses are scheduled to not disturb radio events. See [Flash API timing](#) on page 81 for details. If the protocol radio events are in a critical state, flash memory accesses may be delayed for a long period resulting in a time-out event. In this case, `NRF_EVT_FLASH_OPERATION_ERROR` will be returned in the application event handler. If this happens, retry the flash memory operation. Examples of typical critical phases of radio events include connection setup, connection update, disconnection, and impending supervision time-out.

The probability of successfully accessing the flash memory decreases with increasing scheduler activity (i.e. radio activity and timeslot activity). With long connection intervals, there will be a higher probability of accessing flash memory successfully. Use the guidelines in [Table 7: Behavior with Bluetooth Low Energy traffic and concurrent flash write/erase](#) on page 30 to improve the probability of flash operation success. The table assumes a flash write size of four bytes. LE 1M PHY is assumed unless another PHY is specified.

**Note:** Flash page (4096 bytes) erase can take up to 89.7 ms, and a 4-byte flash write can take up to 338  $\mu$ s. A flash write must be made in chunks smaller or equal to the flash page size. Make flash writes in as small chunks as possible to increase the probability of success and reduce chances of affecting *Bluetooth* Low Energy performance.

<b>Bluetooth Low Energy activity</b>	<b>Flash write/erase</b>
High Duty cycle directed advertising	Does not allow flash operation while advertising is active (maximum 1.28 seconds). In this case, retrying flash operation will only succeed after the advertising activity has finished.
All possible <i>Bluetooth</i> Low Energy roles running concurrently (connections as a Central, Peripheral, Advertiser, and Scanner)	Low to medium probability of flash operation success Probability of success increases with: <ul style="list-style-type: none"><li>• Configurations with shorter event lengths</li><li>• Lower data traffic</li><li>• Increase in connection interval and advertiser interval</li><li>• Decrease in scan window</li><li>• Increase in scan interval</li></ul>

Bluetooth Low Energy activity	Flash write/erase
Extended scanner	Medium to high probability of flash operation success.  When receiving extended advertising events with secondary channel packets, the scanner cannot choose when the secondary channel timing-events will occur.  Probability of success increases with: <ul style="list-style-type: none"> <li>• Lower secondary channel traffic</li> </ul> Probability of success may increase with: <ul style="list-style-type: none"> <li>• Decrease in scan window</li> <li>• Increase in scan interval</li> </ul>
Extended scannable advertiser with the following configurations: <ul style="list-style-type: none"> <li>• 255 bytes of scan response data</li> <li>• Advertising interval <math>\geq 100</math> ms</li> <li>• 3 primary advertising channels</li> </ul>	High probability of flash operation success
8 high bandwidth connections as a Central 1 high bandwidth connection as a Peripheral All active connections fulfill the following criteria: <ul style="list-style-type: none"> <li>• Supervision time-out <math>&gt; 6 \times</math> connection interval</li> <li>• Connection interval <math>\geq 150</math> ms</li> <li>• All central connections have the same connection interval</li> </ul>	High probability of flash write success  Medium probability of flash erase success (High probability if the connection interval is $> 240$ ms)
8 high bandwidth connections as a Central All active connections fulfill the following criteria: <ul style="list-style-type: none"> <li>• Supervision time-out <math>&gt; 6 \times</math> connection interval</li> <li>• Connection interval <math>\geq 150</math> ms</li> <li>• All connections have the same connection interval</li> </ul>	High probability of flash operation success
8 low bandwidth connections as a Central All active connections fulfill the following criteria: <ul style="list-style-type: none"> <li>• Supervision time-out <math>&gt; 6 \times</math> connection interval</li> <li>• Connection interval <math>\geq 110</math> ms</li> <li>• All connections have the same connection interval</li> </ul>	High probability of flash operation success
1 connection as a Peripheral The active connection fulfills the following criteria: <ul style="list-style-type: none"> <li>• Supervision time-out <math>&gt; 6 \times</math> connection interval</li> <li>• Connection interval <math>\geq 25</math> ms</li> </ul>	High probability of flash operation success

<b>Bluetooth Low Energy activity</b>	<b>Flash write/erase</b>
4 connections as a Peripheral All active connections fulfill the following criteria: <ul style="list-style-type: none"> <li>• Supervision time-out &gt; 6 x connection interval</li> <li>• Connection interval <math>\geq</math> 115 ms</li> </ul>	Medium to high probability of flash operation success.  The scheduling of connections as Peripheral is done by the peer devices. The Peripheral does not influence this scheduling, which means that the connection events may collide and result in flash operations being blocked. With multiple connections as Peripheral, choose connection intervals and connection event lengths in a way that leaves enough free time to handle collisions and other activities.
Connectable Undirected Advertising Nonconnectable Advertising Scannable Advertising Connectable Low Duty Cycle Directed Advertising	High probability of flash operation success
No <i>Bluetooth</i> Low Energy activity	Flash operation will always succeed

*Table 7: Behavior with Bluetooth Low Energy traffic and concurrent flash write/erase*



# 9 Multiprotocol support

Multiprotocol support allows developers to implement their own 2.4 GHz proprietary protocol in the application both when the SoftDevice is not in use (non-concurrent) and while the SoftDevice protocol stack is in use (concurrent). For concurrent multiprotocol implementations, the Radio Timeslot API allows the application protocol to safely schedule radio usage between *Bluetooth* Low Energy events.

## 9.1 Non-concurrent multiprotocol implementation

For non-concurrent operation, a proprietary 2.4 GHz protocol can be implemented in the application program area and can access all hardware resources when the SoftDevice is disabled. The SoftDevice may be disabled and enabled without resetting the application in order to switch between a proprietary protocol stack and *Bluetooth* communication.

## 9.2 Concurrent multiprotocol implementation using the Radio Timeslot API

The Radio Timeslot API allows the nRF52 device to be part of a network using the SoftDevice protocol stack and an alternative network of wireless devices at the same time.

The Radio Timeslot (or, simply Timeslot) feature gives the application access to the radio and other restricted peripherals during defined time intervals, denoted as timeslots. The Timeslot feature achieves this by cooperatively scheduling the application's use of these peripherals with those of the SoftDevice. Using this feature, the application can run other radio protocols (third party, custom, or proprietary protocols running from application space) concurrently with the internal protocol stack of the SoftDevice. It can also be used to suppress SoftDevice radio activity and to reserve guaranteed time for application activities with hard timing requirements, which cannot be met by using the *SoC* Radio Notifications.

The Timeslot feature is part of the *SoC* library. The feature works by having the SoftDevice time-multiplex access to peripherals between the application and itself. Through the *SoC API*, the application can open a Timeslot session and request timeslots. When a Timeslot request is granted, the application has exclusive and real-time access to the normally blocked RADIO, TIMER0, CCM, and AAR peripherals and can use these freely for the duration (length) of the timeslot. See [Table 3: Hardware access type definitions](#) on page 25 and [Table 4: Peripheral protection and usage by SoftDevice](#) on page 25.

### 9.2.1 Request types

There are two types of Radio Timeslot requests, *earliest possible* Timeslot requests and *normal* Timeslot requests.

Timeslots may be requested as *earliest possible*, in which case the timeslot occurs at the first available opportunity. In the request, the application can limit how far into the future the timeslot may be placed.

**Note:** The first request in a session must always be *earliest possible* to create the timing reference point for later timeslots.

Timeslots may also be requested at a given time (*normal*). In this case, the application specifies in the request when the timeslot should start and the time is measured from the start of the previous timeslot.

The application may also request to extend an ongoing timeslot. Extension requests may be repeated, prolonging the timeslot even further.

Timeslots requested as *earliest possible* are useful for single timeslots and for non-periodic or non-timed activity. Timeslots requested at a given time relative to the previous timeslot are useful for periodic and timed activities, for example, a periodic proprietary radio protocol. Timeslot extension may be used to secure as much continuous radio time as possible for the application, for example, running an “always on” radio listener.

## 9.2.2 Request priorities

Radio Timeslots can be requested at either high or normal priority, indicating how important it is for the application to access the specified peripherals. A Timeslot request can only be blocked or canceled due to an overlapping SoftDevice activity that has a higher scheduling priority.

## 9.2.3 Timeslot length

A Radio Timeslot is requested for a given length. Ongoing timeslots have the possibility to be extended.

The length of the timeslot is specified by the application in the Timeslot request and ranges from 100  $\mu$ s to 100 ms. Longer continuous timeslots can be achieved by requesting to extend the current timeslot. A timeslot may be extended multiple times, as long as its duration does not extend beyond the time limits set by other SoftDevice activities, and up to a maximum length of 128 seconds.

## 9.2.4 Scheduling

The SoftDevice includes a scheduler which manages radio timeslots and priorities and sets up timers to grant timeslots.

Whether a Timeslot request is granted and access to the peripherals is given is determined by the following factors:

- The time the request is made
- The exact time in the future the timeslot is requested for
- The desired priority level of the request
- The length of the requested timeslot

[Timeslot API timing](#) on page 81 explains how timeslots are scheduled. Timeslots requested at high priority will cancel other activities scheduled at lower priorities in case of a collision. Requests for short timeslots have a higher probability of succeeding than requests for longer timeslots because shorter timeslots are easier to fit into the schedule.

**Note:** Radio Notification signals behave the same way for timeslots requested through the Radio Timeslot interface as for SoftDevice internal activities. See section [Radio Notification signals](#) on page 53 for more information. If Radio Notifications are enabled, Radio Timeslots will be notified.

## 9.2.5 High-frequency clock configuration

The application can request the SoftDevice to guarantee that the HFCLK source is set to the external crystal and that it is ramped up and stable before the start of the timeslot.

If the application requests the SoftDevice to have the external high-frequency crystal ready by the start of the timeslot, the SoftDevice will handle all the enabling and disabling of the crystal. The application does not need to disable the crystal at the end of the timeslot. The SoftDevice will disable the crystal after the end of the timeslot unless the SoftDevice needs to use it within a short period of time after the end of the timeslot. In that case, the SoftDevice will leave the crystal running.

If the application does not request the SoftDevice to have the external high-frequency crystal ready by the start of the timeslot, then the application must not use the RADIO during the timeslot and must take into consideration that the HFCLK source is inaccurate during the timeslot unless the application itself makes

sure that the crystal is ramped up and ready at the start of the timeslot. If the application starts the crystal before or during the timeslot, it is the responsibility of the application to disable it again.

## 9.2.6 Performance considerations

The Radio Timeslot API shares core peripherals with the SoftDevice, and application-requested timeslots are scheduled along with other SoftDevice activities. Therefore, the use of the Timeslot feature may influence the performance of the SoftDevice.

The configuration of the SoftDevice should be considered when using the Radio Timeslot API. A configuration which uses more radio time for native protocol operation will reduce the available time for serving timeslots and result in a higher risk of scheduling conflicts.

All Timeslot requests should use the lowest priority to minimize disturbances to other activities. See [Table 30: Scheduling priorities](#) on page 72 for the scheduling priorities of the different activities. The high priority should only be used when required, such as for running a radio protocol with certain timing requirements that are not met by using normal priority. By using the highest priority available to the Timeslot API, non-critical SoftDevice radio protocol traffic may be affected. The SoftDevice radio protocol has access to higher priority levels than the application. These levels will be used for important radio activity, for instance when the device is about to lose a connection.

See [Scheduling](#) on page 71 for more information on how priorities work together with other modules like the *Bluetooth* Low Energy protocol stack, the Flash API etc.

Timeslots should be kept as short as possible in order to minimize the impact on the overall performance of the device. Requesting a short timeslot will make it easier for the scheduler to fit in between other scheduled activities. The timeslot may later be extended. This will not affect other sessions, as it is only possible to extend a timeslot if the extended time is unreserved.

It is important to ensure that a timeslot has completed its outstanding operations before the time it is scheduled to end (based on its starting time and requested length); otherwise, the SoftDevice behavior is undefined and may result in an unrecoverable fault.

## 9.2.7 Radio Timeslot API

This section describes the calls, events, signals, and return actions of the Radio Timeslot API.

A Timeslot session is opened and closed using *API* calls. Within a session, there is a *API* call to request timeslots. For communication back to the application, the Timeslot feature will generate events and signals. The generated events are handled by the normal application event handler, while the Timeslot signals must be handled by a callback function (the signal handler) provided by the application. The signal handler can also return actions to the SoftDevice. Within a timeslot, only the signal handler is used.

**Note:** The *API* calls, events, and signals are only given by their full names in the tables where they are listed the first time. Elsewhere, only the last part of the name is used.

### 9.2.7.1 API calls

The S132 SoftDevice provides *API* functions for handling radio timeslots.

The *API* functions are defined in the following table.

API call	Description
<code>sd_radio_session_open()</code>	Open a radio timeslot session.
<code>sd_radio_session_close()</code>	Close a radio timeslot session.
<code>sd_radio_request()</code>	Request a radio timeslot.

Table 8: API calls

### 9.2.7.2 Radio Timeslot events

Events come from the SoftDevice scheduler and are used for Radio Timeslot session management.

Events are received in the application event handler callback function, which will typically be run in an application interrupt. For more information, see [Events - SoftDevice to application](#) on page 17. The events are defined in the following table.

Event	Description
<code>NRF_EVT_RADIO_SESSION_IDLE</code>	Session status: The current timeslot session has no remaining scheduled timeslots.
<code>NRF_EVT_RADIO_SESSION_CLOSED</code>	Session status: The timeslot session is closed and all acquired resources are released.
<code>NRF_EVT_RADIO_BLOCKED</code>	Timeslot status: The last requested timeslot could not be scheduled, due to a collision with already scheduled activity or for other reasons.
<code>NRF_EVT_RADIO_CANCELED</code>	Timeslot status: The scheduled timeslot was canceled due to overlapping activity of higher priority.
<code>NRF_EVT_RADIO_SIGNAL_CALLBACK_INVALID_RETURN</code>	Signal handler: The last signal handler return value contained invalid parameters and the timeslot was ended.

Table 9: Radio Timeslot events

### 9.2.7.3 Radio Timeslot signals

Signals come from the peripherals and arrive within a Radio Timeslot.

Signals are received in a signal handler callback function that the application must provide. The signal handler runs in interrupt priority level 0, which is the highest priority in the system, see section [Interrupt priority levels](#) on page 86.

Signal	Description
NRF_RADIO_CALLBACK_SIGNAL_TYPE_START	Start of the timeslot. The application now has exclusive access to the peripherals for the full length of the timeslot.
NRF_RADIO_CALLBACK_SIGNAL_TYPE_RADIO	Radio interrupt. For more information, see chapter 2.4 GHz radio (RADIO) in the nRF52 Reference Manual.
NRF_RADIO_CALLBACK_SIGNAL_TYPE_TIMER0	Timer interrupt. For more information, see chapter Timer/counter (TIMER) in the nRF52 Reference Manual.
NRF_RADIO_CALLBACK_SIGNAL_TYPE_EXTEND_SUCCEEDED	The latest extend action succeeded.
NRF_RADIO_CALLBACK_SIGNAL_TYPE_EXTEND_FAILED	The latest extend action failed.

Table 10: Radio Timeslot signals

#### 9.2.7.4 Signal handler return actions

The return value from the application signal handler to the SoftDevice contains an action.

Signal	Description
NRF_RADIO_SIGNAL_CALLBACK_ACTION_NONE	The timeslot processing is not complete. The SoftDevice will take no action.
NRF_RADIO_SIGNAL_CALLBACK_ACTION_END	The current timeslot has ended. The SoftDevice can now resume other activities.
NRF_RADIO_SIGNAL_CALLBACK_ACTION_REQUEST_AND_END	The current timeslot has ended. The SoftDevice is requested to schedule a new timeslot, after which it can resume other activities.
NRF_RADIO_SIGNAL_CALLBACK_ACTION_EXTEND	The SoftDevice is requested to extend the ongoing timeslot.

Table 11: Signal handler action return values

#### 9.2.7.5 Ending a timeslot in time

The application is responsible for keeping track of timing within the Radio Timeslot and for ensuring that the application's use of the peripherals does not last for longer than the granted timeslot length.

For these purposes, the application is granted access to the TIMER0 peripheral for the length of the timeslot. This timer is started from zero by the SoftDevice at the start of the timeslot and is configured to run at 1 MHz. The recommended practice is to set up a timer interrupt that expires before the timeslot expires, with enough time left of the timeslot to do any clean-up actions before the timeslot ends. Such a timer interrupt can also be used to request an extension of the timeslot, but there must still be enough time to clean up if the extension is not granted.

**Note:** The scheduler uses the LFCLK source for time calculations when scheduling events. If the application uses a TIMER (sourced from the current HFCLK source) to calculate and signal the end of a timeslot, it must account for the possible clock drift between the HFCLK source and the LFCLK source.

### 9.2.7.6 Signal handler considerations

The signal handler runs at interrupt priority level 0, which is the highest priority. Therefore, it cannot be interrupted by any other activity.

Since the signal handler runs at a higher interrupt priority (lower numerical value for the priority level) than the *SVC* calls (see [Interrupt priority levels](#) on page 86), *SVC* calls are not available in the signal handler.

**Note:** It is a requirement that processing in the signal handler does not exceed the granted time of the timeslot. If it does, the behavior of the SoftDevice is undefined and the SoftDevice may malfunction.

The signal handler may be called several times during a timeslot. It is recommended to use the signal handler only for real time signal handling. When the application has handled the signal, it can exit the signal handler and wait for the next signal if it wants to do other (less time critical) processing at lower interrupt priority (higher numerical value for the priority level) while waiting.

## 9.3 Radio Timeslot API usage scenarios

In this section, several Radio Timeslot API usage scenarios are provided with descriptions of the sequence of events within them.

### 9.3.1 Complete session example

This section describes a complete Radio Timeslot session.

**Figure 3: Complete Radio Timeslot session example** on page 39 shows a complete Timeslot session. In this case, only timeslot requests from the application are being scheduled, and there is no SoftDevice activity.

At start, the application calls the *API* to open a session and to request a first timeslot (which must be of type *earliest possible*). The SoftDevice schedules the timeslot. At the start of the timeslot, the SoftDevice calls the application signal handler with the *START* signal. After this, the application is in control and has access to the peripherals. The application will then typically set up *TIMER0* to expire before the end of the timeslot to get a signal indicating that the timeslot is about to end. In the last signal in the timeslot, the application uses the signal handler return action to request a new timeslot 100 ms after the first.

All subsequent timeslots are similar. The signal handler is called with the *START* signal at the start of the timeslot. The application then has control, but must arrange for a signal to come towards the end of the timeslot. As the return value for the last signal in the timeslot, the signal handler requests a new timeslot using the *REQUEST\_AND\_END* action.

Eventually, the application does not require the radio any more. Therefore, at the last signal in the last timeslot, the application returns *END* from the signal handler. The SoftDevice then sends an *IDLE* event to the application event handler. The application calls *session\_close*, and the SoftDevice sends the *CLOSED* event. The session has now ended.

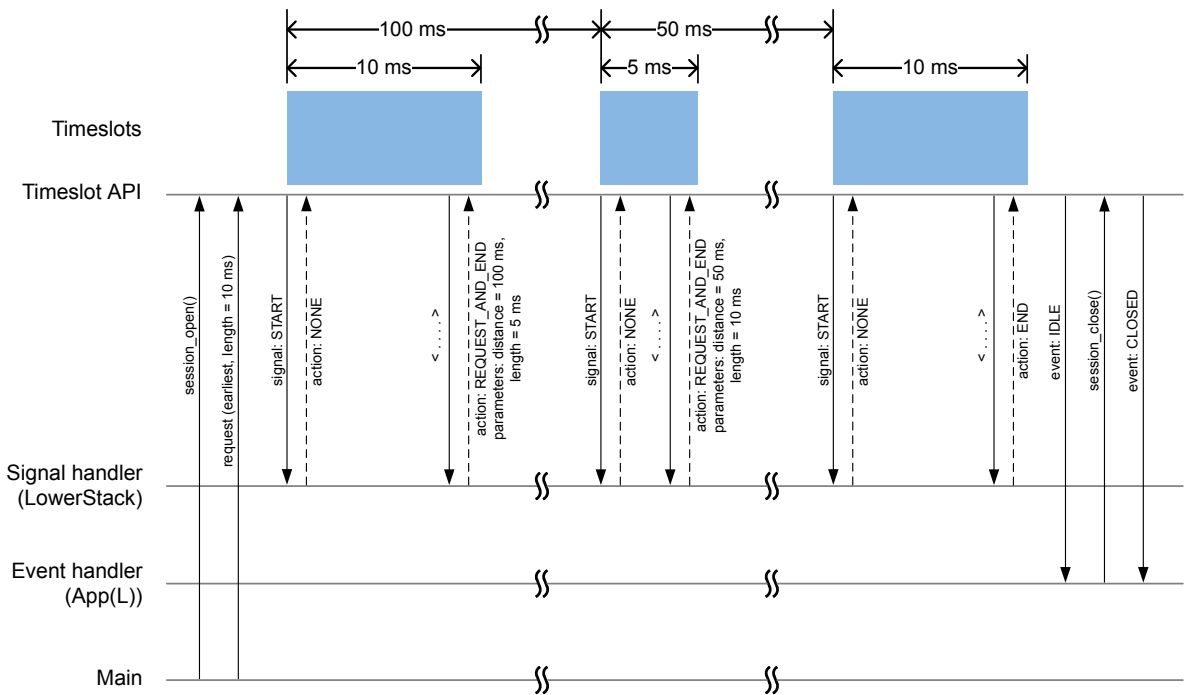

Figure 3: Complete Radio Timeslot session example

LowerStack denotes the interrupt level for SoftDevice *API* calls and non-time-critical processing, and App(L) denotes the selected low-priority application interrupt level. See [Interrupt priority levels](#) on page 86 for the available interrupt levels.

### 9.3.2 Blocked timeslot scenario

Radio Timeslot requests may be blocked due to an overlap with activities already scheduled by the SoftDevice.

[Figure 4: Blocked timeslot scenario](#) on page 40 shows a situation in the middle of a session where a requested timeslot cannot be scheduled. At the end of the first timeslot illustrated here, the application signal handler returns a REQUEST\_AND\_END action to request a new timeslot. The new timeslot cannot be scheduled as requested because of a collision with an already scheduled SoftDevice activity. The application is notified about this by a BLOCKED event to the application event handler. The application then makes a new request for a later point in time. This request succeeds (it does not collide with anything), and a new timeslot is eventually scheduled.

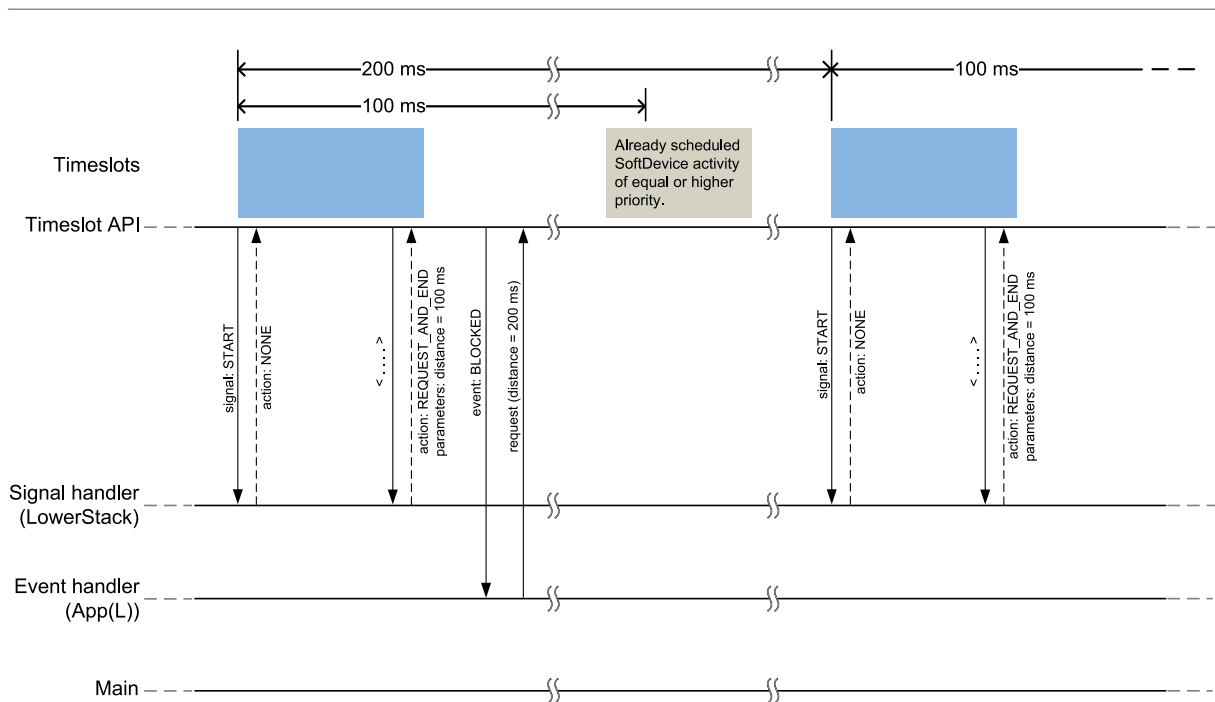

Figure 4: Blocked timeslot scenario

### 9.3.3 Canceled timeslot scenario

Situations may occur in the middle of a session where a requested and scheduled application radio timeslot is being revoked.

Figure 5: Canceled timeslot scenario on page 41 shows a situation in the middle of a session where a requested and scheduled application timeslot is being revoked. The upper part of the figure shows that the application has ended a timeslot by returning the REQUEST\_AND\_END action, and the new timeslot has been scheduled. The new scheduled timeslot has not started yet, as its starting time is in the future. The lower part of the figure shows the situation some time later.

In the meantime, the SoftDevice has requested some reserved time for a higher priority activity that overlaps with the scheduled application timeslot. To accommodate the higher priority request, the application timeslot is removed from the schedule and, instead, the higher priority SoftDevice activity is scheduled. The application is notified about this by a CANCELED event to the application event handler. The application then makes a new request at a later point in time. That request succeeds (it does not collide with anything), and a new timeslot is eventually scheduled.



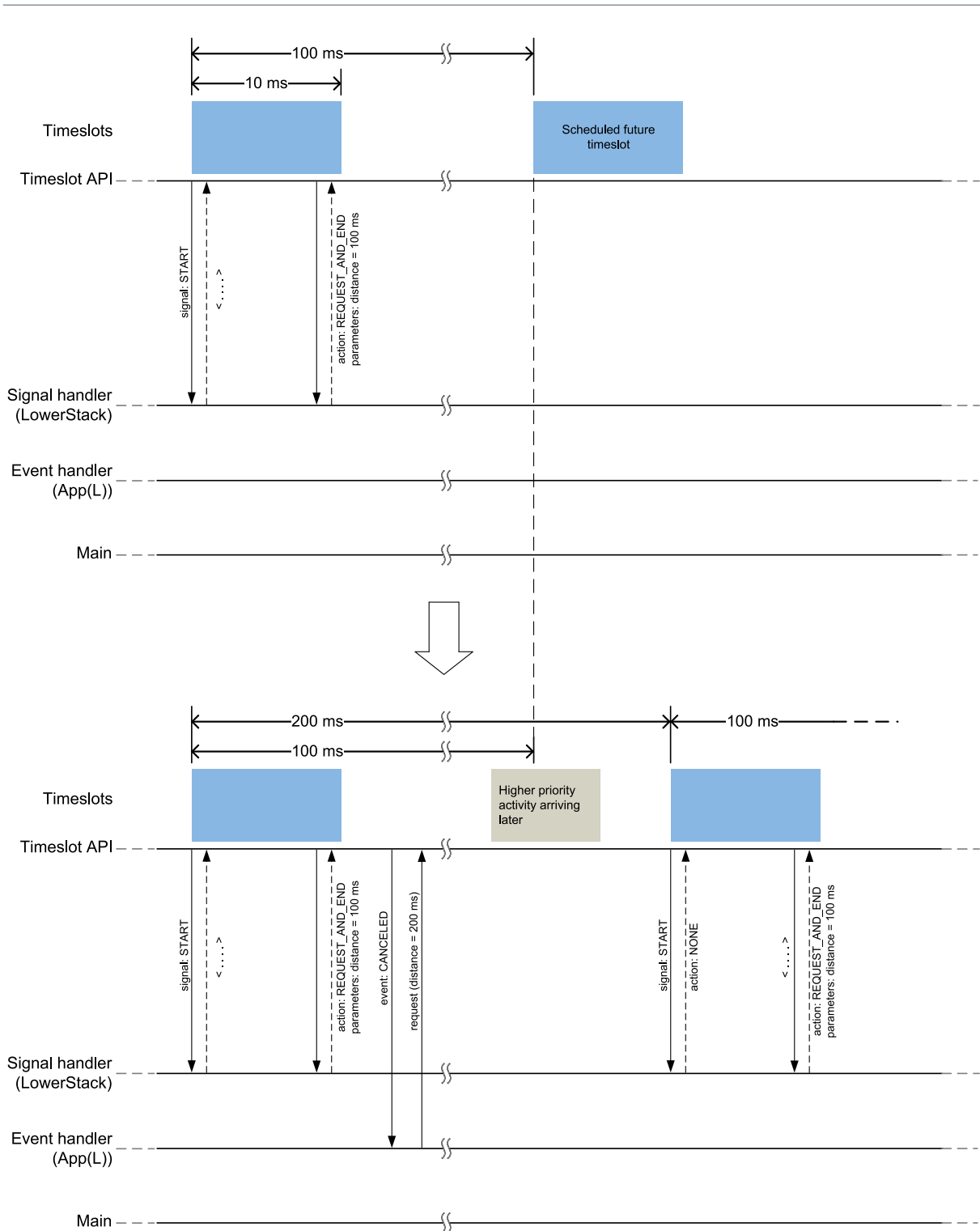

Figure 5: Canceled timeslot scenario

### 9.3.4 Radio Timeslot extension example

An application can use Radio Timeslot extension to create long continuous timeslots that will give the application as much radio time as possible while disturbing the SoftDevice activities as little as possible.

In the first timeslot in [Figure 6: Radio Timeslot extension example](#) on page 42, the application uses the signal handler return action to request an extension of the timeslot. The extension is granted, and the timeslot is seamlessly prolonged. The second attempt to extend the timeslot fails, as a further extension would cause a collision with a SoftDevice activity that has been scheduled. Therefore, the application

makes a new request, of type earliest. This results in a new Radio Timeslot being scheduled immediately after the SoftDevice activity. This new timeslot can be extended a number of times.

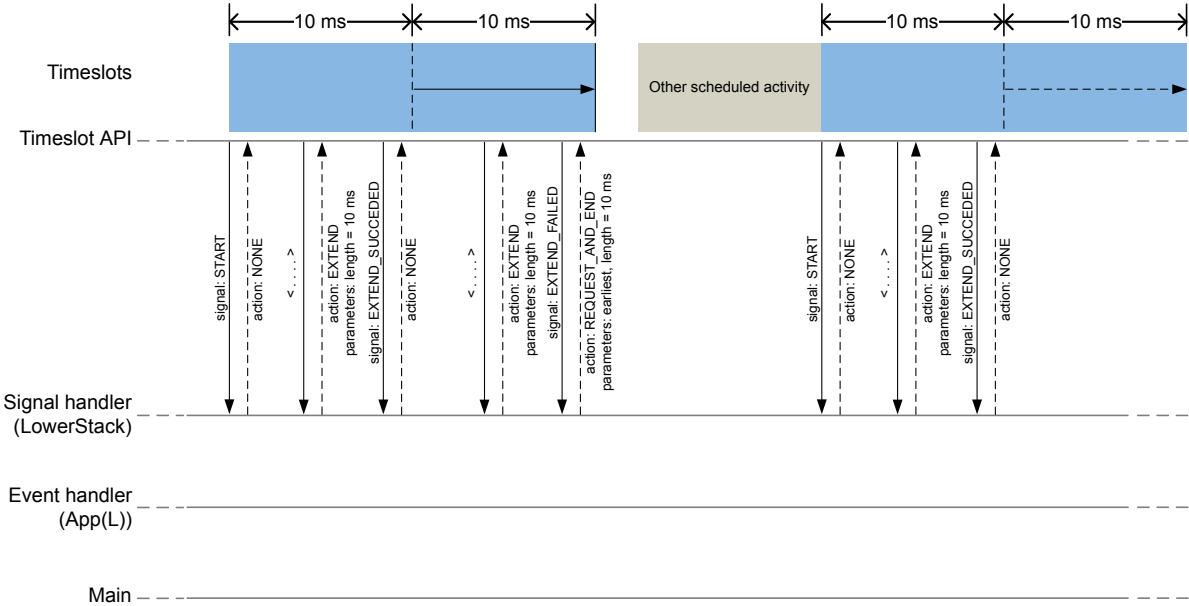

Figure 6: Radio Timeslot extension example

# 10 Bluetooth Low Energy protocol stack

The *Bluetooth* 5 compliant Host and Controller implemented by the SoftDevice are fully qualified with multirole support (Central, Observer, Peripheral, and Broadcaster).

The SoftDevice allows applications to implement standard *Bluetooth* Low Energy profiles as well as proprietary use case implementations. The *API* is defined above the *GATT*, *Generic Access Profile (GAP)*, and *Logical Link Control and Adaptation Protocol (L2CAP)*. Other protocols, such as the *Attribute Protocol (ATT)*, *Security Manager (SM)*, and *Link Layer (LL)*, are managed by the higher layers of the SoftDevice as shown in the following figure.

The nRF5 Software Development Kit (nRF5 SDK) complements the SoftDevice with Service and Profile implementations. Single-mode SoC applications are enabled by the *Bluetooth* Low Energy protocol stack and nRF52 Series SoC.

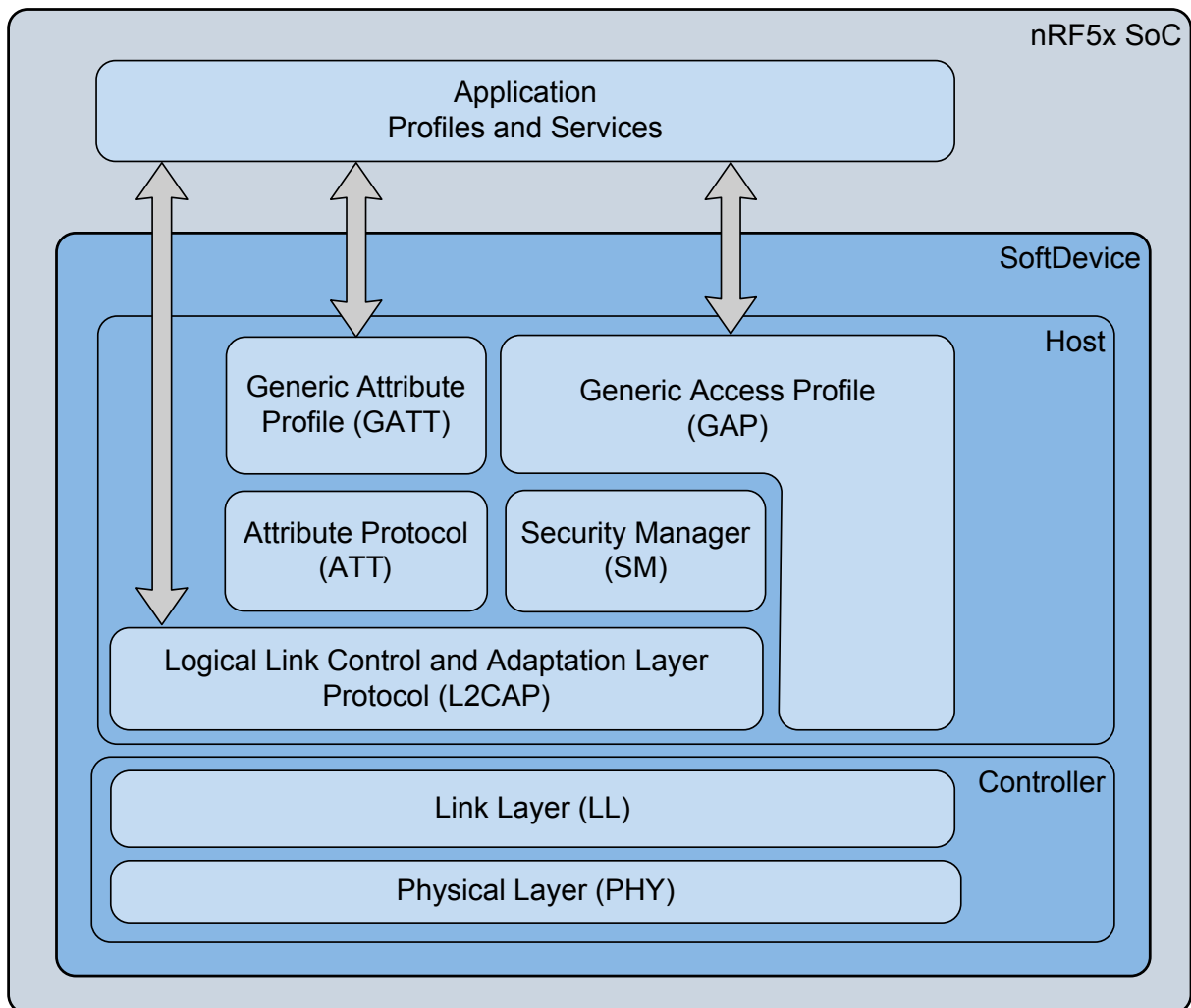

Figure 7: SoftDevice stack architecture

## 10.1 Profile and service support

This section lists the profiles and services adopted by the Bluetooth Special Interest Group at the time of publication of this document.

The SoftDevice supports a number of GATT based profiles which are listed in the following table. The SoftDevice also supports the use of proprietary profiles. The GATT profile specifications can be found on [Bluetooth's website](#) in [GATT Specifications](#).

Adopted profile	Adopted services
<i>Human Interface Device (HID) over GATT</i>	<i>HID</i> Battery Device Information
Heart Rate	Heart Rate Device Information
Proximity	Link Loss Immediate Alert TX Power
Blood Pressure	Blood Pressure Device Information
Health Thermometer	Health Thermometer Device Information
Glucose	Glucose Device Information
Phone Alert Status	Phone Alert Status
Alert Notification	Alert Notification
Time	Current Time Next DST Change Reference Time Update
Find Me	Immediate Alert
Cycling Speed and Cadence	Cycling Speed and Cadence Device Information
Running Speed and Cadence	Running Speed and Cadence Device Information
Location and Navigation	Location and Navigation
Cycling Power	Cycling Power
Scan Parameters	Scan Parameters

Adopted profile	Adopted services
Weight Scale	Weight Scale Body Composition User Data Device Information
Continuous Glucose Monitoring	Continuous Glucose Monitoring Bond Management Device Information
Environmental Sensing	Environmental Sensing
Pulse Oximeter	Pulse Oximeter Device Information Bond Management Battery Current Time
Object Transfer	Object Transfer
Automation IO	Automation IO
	Indoor Positioning
Internet Protocol Support	
Fitness Machine Profile	Fitness Machine Device Information User Data
	Transport Discovery Service (Currently not supported by the SoftDevice)
Reconnection Configuration Profile	Reconnection Configuration Service

Table 12: Supported profiles and services

**Note:** Examples for selected profiles and services are available in the nRF5 SDK. See the nRF5 SDK documentation for details.

## 10.2 Bluetooth Low Energy features

The *Bluetooth* Low Energy protocol stack in the SoftDevice has been designed to provide an abstract but flexible interface for application development for *Bluetooth* Low Energy devices.

*GAP*, *GATT*, *SM*, and *L2CAP* are implemented in the SoftDevice and managed through the *API*. The SoftDevice implements *GAP* and *GATT* procedures and modes that are common to most profiles such as the handling of discovery, connection, data transfer, and bonding.

The *Bluetooth* Low Energy *API* is consistent across *Bluetooth* role implementations where common features have the same interface. The following tables describe the features found in the *Bluetooth* Low Energy protocol stack.

API features	Description
Interface to <i>GATT/GAP</i>	Consistency between <i>APIs</i> including shared data formats
Attribute table sizing, population, and access	Full flexibility to size the attribute table at application compile time and to populate it at run time. Attribute removal is not supported.
Asynchronous and event driven	Thread-safe function and event model enforced by the architecture
Vendor-specific (128-bit) UUIDs for proprietary profiles	Compact, fast, and memory efficient management of 128-bit UUIDs
Packet flow control	Full application control over data buffers to ensure maximum throughput
Application control of PHY	Full application control over the PHYs negotiated in connections
Application control of MTU size and packet length	Full application control of MTU size and packet length used in connections

Table 13: *API features in the Bluetooth Low Energy stack*

GAP features	Description
Multirole	Central, Peripheral, Observer, and Broadcaster can run concurrently with connections.
Multiple bond support	Keys and peer information stored in application space. No restrictions in stack implementation.
Security Mode 1, Levels 1, 2, 3, and 4	Support for all levels of <i>SM 1</i>

Table 14: *GAP features in the Bluetooth Low Energy stack*

GATT features	Description
<i>GATT</i> Server	Support for one <i>ATT</i> server for all connections Includes configurable Service Changed support
Support for authorization	Enables control points Enables the application to provide fresh data Enables <i>GAP</i> authorization
<i>GATT</i> Client	Flexible data management options for packet transmission with either fine control or abstract management.
Implemented <i>GATT</i> Sub-procedures	Exchange MTU Discover all Primary Services Discover Primary Service by Service UUID Find included Services Discover All Characteristics of a Service Discover Characteristics by UUID Discover All Characteristic Descriptors Read Characteristic Value Read using Characteristic UUID Read Long Characteristic Values Read Multiple Characteristic Values (Client only) Write Without Response Write Characteristic Value Notifications Indications Read Characteristic Descriptors Read Long Characteristic Descriptors Write Characteristic Descriptors Write Long Characteristic Values Write Long Characteristic Descriptors Reliable Writes

Table 15: GATT features in the Bluetooth Low Energy stack

SM features	Description
Flexible key generation and storage for reduced memory requirements	Keys are stored directly in application memory to avoid unnecessary copies and memory constraints.
Authenticated <i>Man-in-the-Middle (MITM)</i> protection	Allows for per-link elevation of the encryption security level.
Pairing methods: Just works, Numeric Comparison, Passkey Entry, and Out of Band	<i>API</i> provides the application full control of the pairing sequences.

Table 16: SM features in the Bluetooth Low Energy stack

ATT features	Description
Server protocol	Fast and memory efficient implementation of the <i>ATT</i> server role
Client protocol	Fast and memory efficient implementation of the <i>ATT</i> client role
Configurable ATT_MTU size	Allows for per-link configuration of ATT_MTU size

Table 17: ATT features in the Bluetooth Low Energy stack

L2CAP features	Description
LE Credit-based Flow Control Mode	Configurable support for up to 64 channels on each link

Table 18: L2CAP features in the Bluetooth Low Energy stack



LL features	Description
Master role Scanner/initiator role	The SoftDevice supports multiple concurrent central connections and an additional scanner or initiator role. The initiator role is not available when the number of available simultaneous connections has been reached, but the scanner role is still supported for new device discovery.
Slave role Advertiser role	The SoftDevice supports multiple concurrent peripheral connections and an additional broadcaster or connectable advertiser. The connectable advertiser cannot be started when the number of available simultaneous connections has been reached, but the advertiser can still be started as a broadcaster.
Channel map configuration	Setup of channel map for all central connections from the application.  Accepting update for the channel map for a peripheral connection.
Master-initiated connection parameter update	Central role may initiate connection parameter update. Peripheral role will accept connection parameter update.
LE Extended Advertising	Scanning, advertising, and connecting on all supported PHYs.  Sending and receiving up to 255 bytes of advertising data using chained advertisements.  Anonymous advertising.
LE Data Packet Length Extension (DLE)	Up to 251 bytes of <i>LL</i> data channel packet payload. Both central and peripheral roles are able to initiate a Data Length Update procedure and respond to a peer-initiated Data Length Update procedure.
LE 1M PHY LE 2M PHY	LE connections transmitting and receiving packets on all PHYs. Both symmetric connections (where the TX and RX PHYs are the same) and asymmetric connections (where the TX and RX PHYs are different) are supported. Both central and peripheral roles are able to initiate a PHY update procedure and respond to a peer-initiated PHY update procedure.
Encryption	
RSSI	Channel-specific signal strength measurements during advertising, scanning, and central and peripheral connections.
LE Ping	

LL features	Description
Privacy	The <i>LL</i> can generate and resolve resolvable private addresses in the advertiser, scanner, and initiator roles.
Extended Scanner Filter Policies	

Table 19: LL features in the Bluetooth Low Energy stack

Proprietary features	Description
TX Power control	Access for the application to change transmit power settings for a specific role or connection handle.
MBR for <i>Device Firmware Update (DFU)</i>	Enables over-the-air firmware replacement, including full SoftDevice update capability.
<i>QoS</i> channel survey	Measures the energy level of <i>Bluetooth</i> Low Energy channels. The application can then set an adapted channel map to avoid busy channels.
Channel map for Observer role	Access for the application to set a channel map for the Observer role. This can be used to avoid busy or uninteresting channels.

Table 20: Proprietary features in the Bluetooth Low Energy stack

## 10.3 Limitations on procedure concurrency

When the SoftDevice has established multiple connections as a Central, the concurrency of protocol procedures will have some limitations.

The Host instantiates both *GATT* and *GAP* instances for each connection, while the *SM* Initiator has a configurable number of instantiations. The *LL* also has concurrent procedure limitations that are handled inside the SoftDevice without requiring management from the application.

Protocol procedures	Limitation with multiple connections
<i>GATT</i>	None. All procedures can be executed in parallel.
<i>GAP</i>	None. All procedures can be executed in parallel. Note that some <i>GAP</i> procedures require <i>LL</i> control procedures (connection parameter update and encryption). In this case, the <i>GAP</i> module will queue the <i>LL</i> procedures and execute them in sequence.
<i>SM</i>	None. The procedures for all peripheral connections can be executed in parallel. The number of concurrent procedures for central connections are fully configurable.
<i>LL</i>	The <i>LL</i> Disconnect procedure has no limitations and can be executed on any or all links simultaneously.  The <i>LL</i> connection parameter update on a master link can only be executed on one master link at a time.  Accepting connection parameter update and encryption establishment on a slave link is always allowed irrespective of any control procedure running on master links.

Table 21: Limitations on procedure concurrency

## 10.4 Bluetooth Low Energy role configuration

The S132 SoftDevice stack supports concurrent operation in multiple *Bluetooth* Low Energy roles. The roles available can be configured when the S132 SoftDevice stack is enabled at runtime.

The SoftDevice provides a mechanism for enabling the number of central or peripheral roles the application can run concurrently, and for enabling *QoS* channel survey. The SoftDevice can be configured with multiple connections as a Central or a Peripheral. The SoftDevice supports running one connectable Advertiser or Broadcaster and one Scanner or Observer concurrently with the *Bluetooth* Low Energy connections.

An Initiator or a connectable Advertiser can only be started if the number of connections is less than the maximum supported.

When the SoftDevice is enabled, it will allocate memory for the connections the application has requested. The SoftDevice will make sure that it has enough buffers to avoid buffer starvation within a connection event if the application processes the SoftDevice events immediately when they are raised. The SoftDevice will also allocate memory for the *QoS* channel survey if the application has enabled it.

The SoftDevice supports per connection bandwidth configuration by giving the application control over the connection interval and the length of the connection event. By default, connections are set to have an event length of 3.75 ms. This is sufficient for three packet pairs in a connection event with the default 27 octet-long *LL* payload for Data Channel PDUs.

The connection bandwidth can be increased by enabling Connection Event Length Extension. See [Connection timing with Connection Event Length Extension](#) on page 80 for more information. Enabling Connection Event Length Extension does not increase the size of the SoftDevice memory pools.

Bandwidth and multilink scheduling can affect each other. See [Scheduling](#) on page 71 for details. Knowledge about multilink scheduling can be used to get improved performance on all links. Refer to [Suggested intervals and windows](#) on page 81 for details about recommended configurations.

# 11 Radio Notification

The Radio Notification is a configurable feature that enables ACTIVE and INACTIVE (nACTIVE) signals from the SoftDevice to the application notifying it when the radio is in use.

## 11.1 Radio Notification signals

Radio notification signals are used to inform the application about radio activity.

The Radio Notification signals are sent right before or at the end of defined time intervals of radio operation, namely the SoftDevice or application Radio Events<sup>10</sup>.

Radio notifications behave differently when Connection Event Length Extension is enabled. [Radio Notification with Connection Event Length Extension](#) on page 61 explains the behavior when this feature is enabled. Otherwise, this chapter assumes that the feature is disabled.

To ensure that the Radio Notification signals behave in a consistent way, the Radio Notification shall always be configured when the SoftDevice is in an idle state with no protocol stack or other SoftDevice activity in progress. Therefore, it is recommended to configure the Radio Notification signals directly after the SoftDevice has been enabled.

If it is enabled, the ACTIVE signal is sent before the Radio Event starts. Similarly, if the nACTIVE signal is enabled, it is sent at the end of the Radio Event. These signals can be used by the application developer to synchronize the application logic with the radio activity. For example, the ACTIVE signal can be used to switch off external devices to manage peak current drawn during periods when the radio is ON, or to trigger sensor data collection for transmission during the upcoming Radio Event.

The notification signals are sent using software interrupt as specified in [Table 5: Allocation of software interrupt vectors to SoftDevice signals](#) on page 28.

As both ACTIVE and nACTIVE use the same software interrupt, it is up to the application to manage them. If both ACTIVE and nACTIVE are configured ON by the application, there will always be an ACTIVE signal before an nACTIVE signal.

Refer to [Table 22: Radio Notification notation and terminology](#) on page 54 for the notation that is used in this section.

When there is sufficient time between Radio Events ( $t_{\text{gap}} > t_{\text{ndist}}$ ), both the ACTIVE and nACTIVE notification signals will be present at each Radio Event. [Figure 8: Two radio events with ACTIVE and nACTIVE signals](#) on page 53 illustrates an example of this scenario with two Radio Events. The figure also illustrates the ACTIVE and nACTIVE signals with respect to the Radio Events.

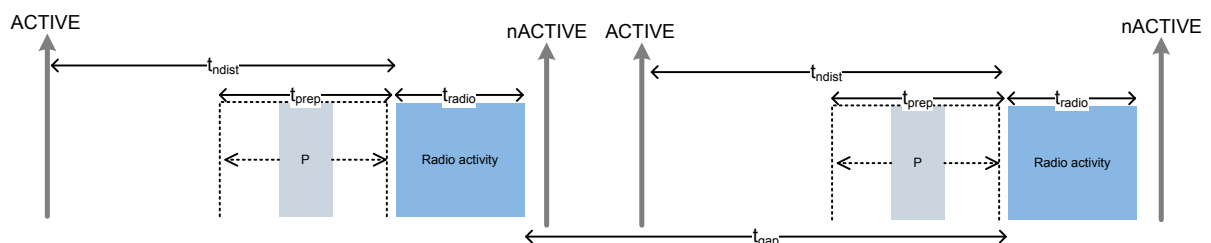

Figure 8: Two radio events with ACTIVE and nACTIVE signals

<sup>10</sup> Application Radio Events are defined as Radio Timeslots, see [Multiprotocol support](#) on page 33.

When there is not sufficient time between the Radio Events ( $t_{\text{gap}} < t_{\text{ndist}}$ ), the ACTIVE and nACTIVE notification signals will be skipped. There will still be an ACTIVE signal before the first event and an nACTIVE signal after the last event. This is shown in [Figure 9: Two radio events without ACTIVE and nACTIVE signals between the events](#) on page 54 that illustrates two radio events where  $t_{\text{gap}}$  is too small and the notification signals will not be available between the events.

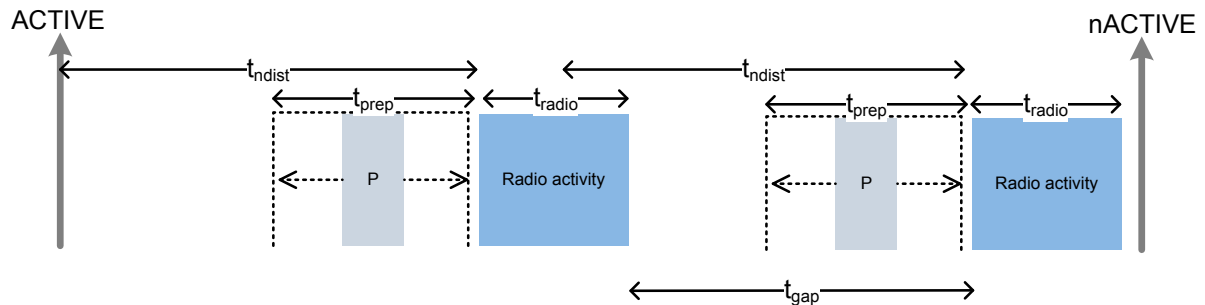

Figure 9: Two radio events without ACTIVE and nACTIVE signals between the events

Label	Description	Notes
ACTIVE	The ACTIVE signal prior to a Radio Event	
nACTIVE	The nACTIVE signal after a Radio Event	Because both ACTIVE and nACTIVE use the same software interrupt, it is up to the application to manage them. If both ACTIVE and nACTIVE are configured ON by the application, there will always be an ACTIVE signal before an nACTIVE signal.
P	SoftDevice CPU processing in interrupt priority level 0 between the ACTIVE signal and the start of the Radio Event	The CPU processing may occur anytime, up to $t_{\text{prep}}$ before the start of the Radio Event.
RX	Reception of packet	
TX	Transmission of packet	
$t_{\text{radio}}$	The total time of a Radio Activity in a connection event	
$t_{\text{gap}}$	The time between the end of one Radio Event and the start of the following one	
$t_{\text{ndist}}$	The notification distance - the time between the ACTIVE signal and the first RX/TX in a Radio Event	This time is configurable by the application developer.
$t_{\text{prep}}$	The time before first RX/TX available to the protocol stack to prepare and configure the radio	The application will be interrupted by a SoftDevice interrupt handler at priority level 0 $t_{\text{prep}}$ time units before the start of the Radio Event.  <b>Note:</b> All packet data to send in an event should be sent to the stack $t_{\text{prep}}$ before the Radio Event starts.
$t_{\text{p}}$	Time used for preprocessing before the Radio Event	

Label	Description	Notes
$t_{\text{interval}}$	Time period of periodic protocol Radio Events (e.g. <i>Bluetooth</i> Low Energy connection interval)	
$t_{\text{event}}$	Total Length of a Radio Event, including processing overhead	The length of a Radio Event for connected roles can be configured per connection by the application. This includes all the overhead associated with the Radio Event. This means that for a central link the event length is also the minimum time between the start of adjacent central role Radio events and between the last central role radio event and the scanner. Connection Event Length Extension does not affect the minimum time between central links.
$t_{\text{ScanReserved}}$	Reserved time needed by the SoftDevice for each ScanWindow	

Table 22: Radio Notification notation and terminology

The application can configure  $t_{\text{ndist}}$  and set the following values ( $\mu\text{s}$ ): 800, 1740, 2680, 3620, 4560, 5500.

Value	Range ( $\mu\text{s}$ )
$t_{\text{prep}}$	167 to 1542
$t_{\text{p}}$	$\leq 165$
$t_{\text{ScanReserved}}$	760

Table 23: Bluetooth Low Energy Radio Notification timing ranges

The timing range for  $t_{\text{radio}}$  depends on the radio activity, as shown in [Table 24: Bluetooth Low Energy Radio Activity \( \$t\_{\text{radio}}\$ \) timing ranges for advertising on LE 1M PHY on page 55](#), [Table 25: Bluetooth Low Energy Radio Activity \( \$t\_{\text{radio}}\$ \) timing ranges for Extended Advertising on page 56](#), and [Table 26: Bluetooth Low Energy Radio Activity \( \$t\_{\text{radio}}\$ \) timing ranges for connected roles on page 56](#).

Radio activity	Range
Undirected and scannable advertising - 0 to 31-byte payload, 3 channels	2750 to 5500 $\mu\text{s}$
Non-connectable advertising - 0 to 31-byte payload, 3 channels	2150 to 2950 $\mu\text{s}$
High-duty cycle directed advertising - 3 channels	1.28 s

Table 24: Bluetooth Low Energy Radio Activity ( $t_{\text{radio}}$ ) timing ranges for advertising on LE 1M PHY

PHY	Radio activity	Range ( $\mu\text{s}$ )
LE 1M PHY	Non-connectable and non-scannable advertising - 0 to 255 bytes, 3 primary advertising channels	2250 to 6650
	Connectable advertising - 0 to 238 bytes, 3 primary advertising channels	3300 to 5050
	Scannable advertising - 0 to 255 bytes, 3 primary advertising channels	2800 to 7550
LE 2M PHY	Non-connectable and non-scannable advertising - 0 to 255 bytes, 3 primary advertising channels	2200 to 4550
	Connectable advertising - 0 to 238 bytes, 3 primary advertising channels	2850 to 3750
	Scannable advertising - 0 to 255 bytes, 3 primary advertising channels	2600 to 5150

Table 25: Bluetooth Low Energy Radio Activity ( $t_{radio}$ ) timing ranges for Extended Advertising

Timing ranges for LE 1M PHY in [Table 25: Bluetooth Low Energy Radio Activity \( \$t\_{radio}\$ \) timing ranges for Extended Advertising](#) on page 56 are valid when LE 1M PHY is used for both primary and secondary advertising channels. Timing ranges for LE 2M PHY are valid when LE 1M PHY is used for primary advertising channels and LE 2M PHY is used for secondary advertising channels.

**Note:** For non-connectable and non-scannable advertising and scannable advertising, the advertiser sends multiple auxiliary packets with data when the number of data bytes is close to the limit of 255 bytes.

For connected roles, the time when the radio is active depends on the PHY. A higher bitrate reduces the radio activity time, while a lower bitrate increases the radio activity time.

PHY	Range ( $\mu\text{s}$ )
LE 1M PHY	310 to $t_{event} - 900$
LE 2M PHY	230 to $t_{event} - 900$

Table 26: Bluetooth Low Energy Radio Activity ( $t_{radio}$ ) timing ranges for connected roles

Based on [Table 22: Radio Notification notation and terminology](#) on page 54, the amount of CPU time available to the application between the ACTIVE signal and the start of the Radio Event is:

$$t_{ndist} - t_p$$

The following expression shows the length of the time interval between the ACTIVE signal and the stack prepare interrupt:

$$t_{ndist} - t_{prep(maximum)}$$

If the data packets are to be sent in the following Radio Event, they must be transferred to the stack using the protocol [API](#) within this time interval.

**Note:**  $t_{prep}$  may be greater than  $t_{ndist}$ . If time is required to handle packets or manage peripherals before interrupts are generated by the stack,  $t_{ndist}$  must be set larger than  $t_{ndist}$ .



## 11.2 Radio Notification on connection events as a Central

This section clarifies the functionality of the Radio Notification feature when the SoftDevice operates as a *Bluetooth* Low Energy Central. The behavior of the notification signals is shown under various combinations of active central links and scanning events.

See [Table 22: Radio Notification notation and terminology](#) on page 54 for the notations used in the text and the figures of this section. For a comprehensive understanding of role scheduling, see [Scheduling](#) on page 71.

For a central link, multiple packets may be exchanged within a single Radio (connection) Event. This is shown in the following figure.

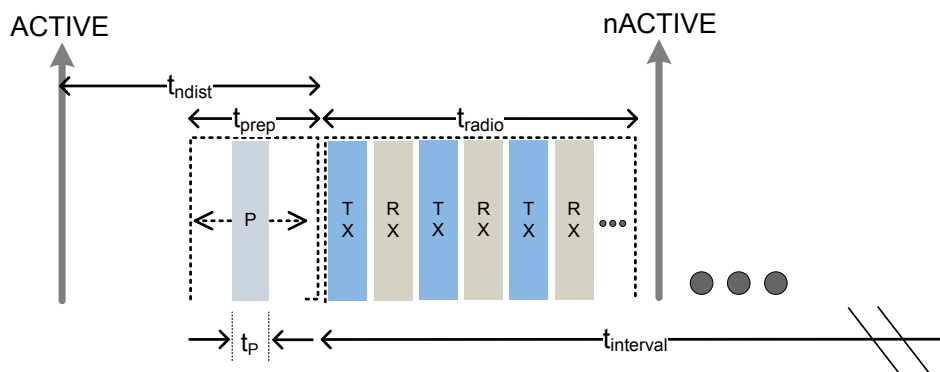

Figure 10: Central link with multiple packet exchange per connection event

To ensure that the ACTIVE notification signal will be available to the application at the configured time when a single central link is established ([Figure 11: Radio Notification signal in relation to a single active link](#) on page 57), the following condition must hold:

$$t_{ndist} + t_{event} - t_{prep} < t_{interval}$$

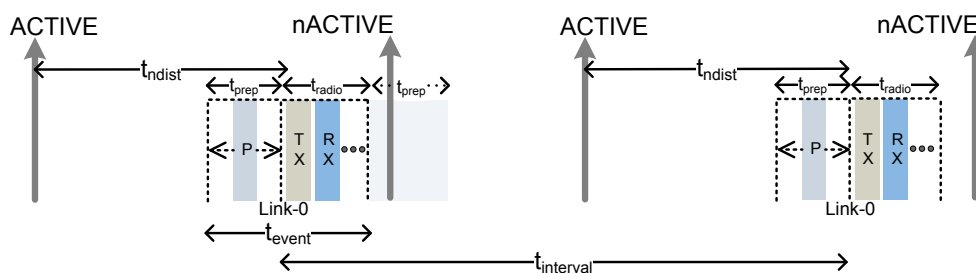

Figure 11: Radio Notification signal in relation to a single active link

A SoftDevice operating as a Central may establish multiple central links and schedule them back-to-back in each connection interval. An example of a Central with three links is shown in [Figure 12: Radio Notification signal with three active Central links](#) on page 58. To ensure that the ACTIVE notification signal will be available to the application at the configured time when three links are established as a Central, the following condition must hold:

$$t_{ndist} + t_{event,0} + t_{event,1} + t_{event,2} - t_{prep} < t_{interval}$$

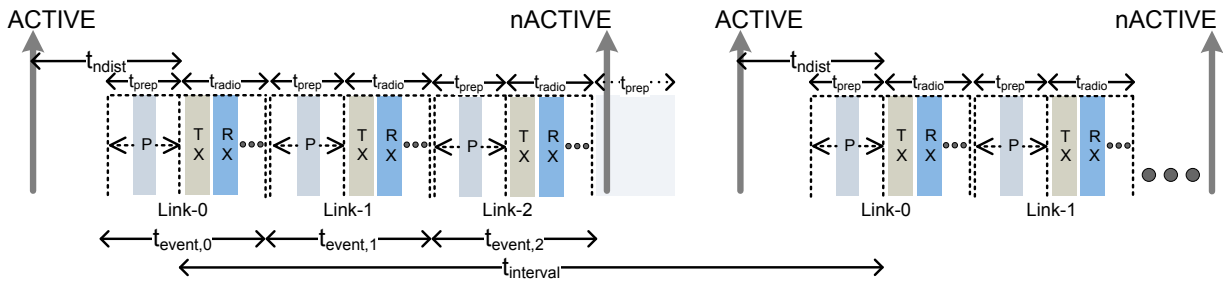

Figure 12: Radio Notification signal with three active Central links

In case one or several central links are dropped, an idle time interval will exist between active central links. If the interval is sufficiently long, the application may unexpectedly receive the Radio Notification signal. In particular, the notification signal will be available to the application in the idle time interval, if this interval is longer than  $t_{ndist}$ . This can be expressed as:

$$\sum_{i=m, \dots, n} t_{event,i} + t_{prep} > t_{ndist}$$

where Link-m, ..., Link-n are consecutive inactive central links.

For example, in the scenario shown in Figure 13: Radio Notification signal with two active Central links on page 58, Link-1 is not active and a gap of  $t_{event,1}$  time units (e.g. ms) exists between Link-0 and Link-2. Consequently, the ACTIVE notification signal will be available to the application, if the following condition holds:

$$t_{event,1} + t_{prep} > t_{ndist}$$

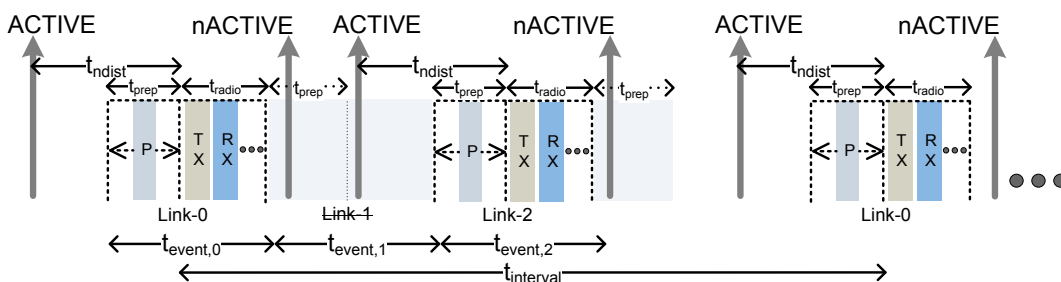

Figure 13: Radio Notification signal with two active Central links

A SoftDevice may additionally run a Scanner in parallel to the central links. This is shown in Figure 14: Radio Notification signals for three active central connections while scanning on page 58, where three central links and a Scanner have been established. To guarantee in this case that the ACTIVE notification signal will be available to the application at the configured time, the following condition must hold:

$$t_{ndist} + t_{event,0} + t_{event,1} + t_{event,2} + Scan\ Window + t_{ScanReserved} < t_{interval}$$

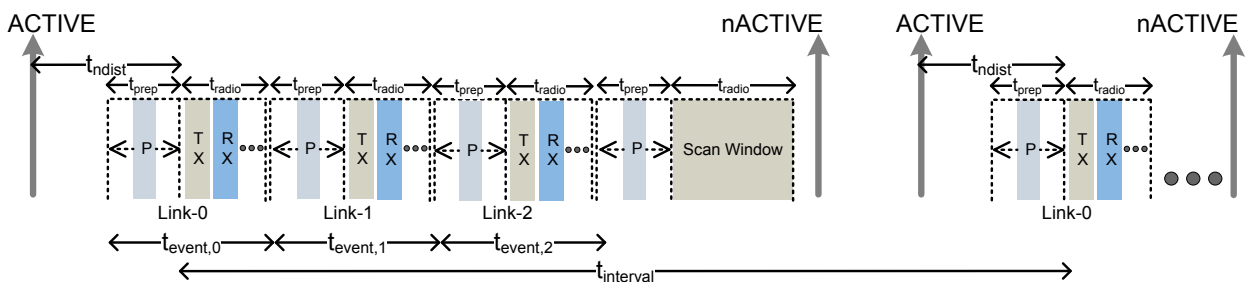

Figure 14: Radio Notification signals for three active central connections while scanning

## 11.3 Radio Notification on connection events as a Peripheral

This section clarifies the functionality of the Radio Notification feature when the SoftDevice operates as a *Bluetooth* Low Energy Peripheral.

Radio Notification events are as shown in the following figure.

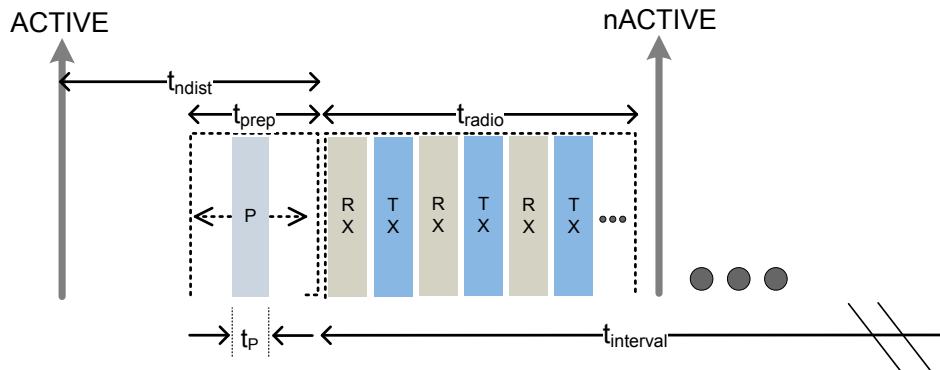

Figure 15: Peripheral link with multiple packet exchange per connection event

To guarantee that the ACTIVE notification signal is available to the application at the configured time when a single peripheral link is established, the following condition must hold:

$$t_{ndist} + t_{radio} < t_{interval}$$

For exceptions, see [Table 27: Maximum peripheral packet transfer per Bluetooth Low Energy Radio Event](#) on page 60.

The SoftDevice will limit the length of a Radio Event ( $t_{radio}$ ), thereby reducing the maximum number of packets exchanged, to accommodate the selected  $t_{ndist}$ . [Figure 16: Consecutive peripheral Radio Events with Radio Notification signals](#) on page 59 shows consecutive Radio Events with Radio Notification signal and illustrates the limitation in  $t_{radio}$  which may be required to guarantee  $t_{ndist}$  is preserved.

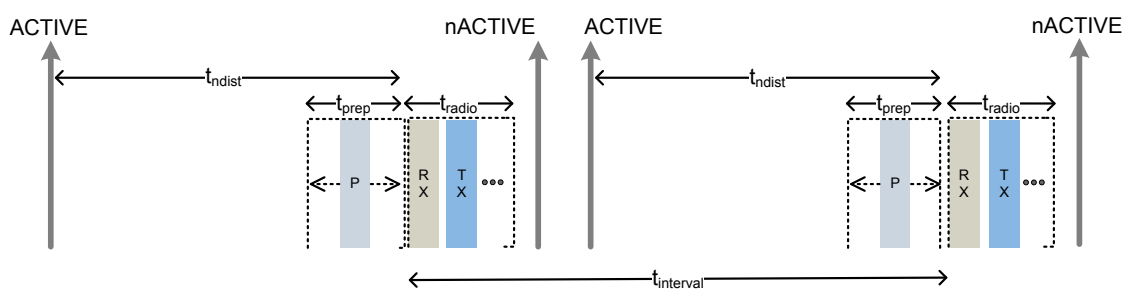

Figure 16: Consecutive peripheral Radio Events with Radio Notification signals

[Table 27: Maximum peripheral packet transfer per Bluetooth Low Energy Radio Event](#) on page 60 shows the limitation on the maximum number of 27-byte packets which can be transferred per Radio Event for given combinations of  $t_{ndist}$  and  $t_{interval}$ .

The data in this table assumes symmetric connections using LE 1M PHY, 27-byte packets, and full-duplex with *Bluetooth* Low Energy connection event length configured to be 7.5 ms and Connection Event Length Extension disabled.

$t_{ndist}$	$t_{interval}$		
	7.5 ms	10 ms	$\geq 15$ ms
800	6	6	6
1740	5	6	6
2680	4	6	6
3620	3	5	6
4560	2	4	6
5500	1	4	6

Table 27: Maximum peripheral packet transfer per Bluetooth Low Energy Radio Event

## 11.4 Radio Notification with concurrent peripheral and central connection events

The Peripheral link events are arbitrarily scheduled with respect to each other and to the Central links. Therefore, if one link event ends too close to the start of a peripheral event, the notification signal before the peripheral connection event might not be available to the application.

Figure 17: Radio Event distance too short to trigger the notification signal on page 60 shows an example where the gap before Link-3 is too short to trigger the nACTIVE and ACTIVE notification signals.

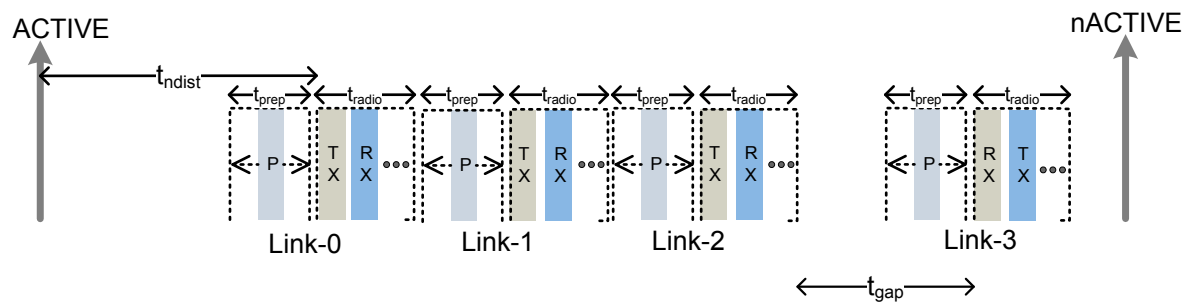

Figure 17: Radio Event distance too short to trigger the notification signal

As shown in Figure 18: Radio Event distance is long enough to trigger notification signal on page 61, the notification signal will arrive if the following condition is met:

$$t_{gap} > t_{ndist}$$

In the figure, the gap before Link-3 is sufficient to trigger the nACTIVE and ACTIVE notification signals.

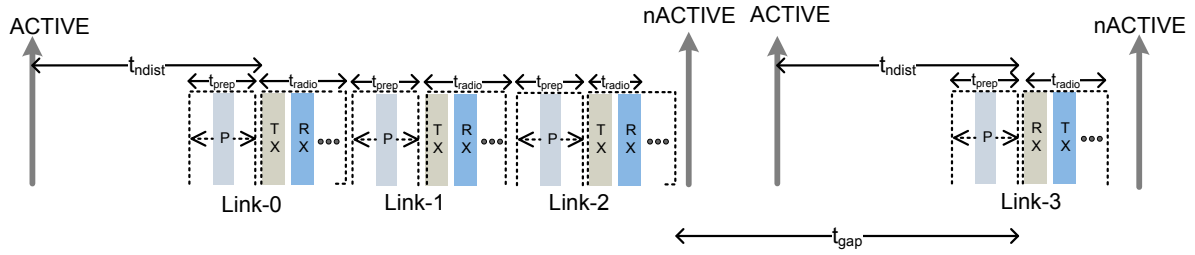

Figure 18: Radio Event distance is long enough to trigger notification signal

## 11.5 Radio Notification with Connection Event Length Extension

This section clarifies the functionality of the Radio Notification signal when Connection Event Length Extension is enabled in the SoftDevice.

When Connection Event Length Extension is enabled, connection events may be extended beyond their initial  $t_{radio}$  to accommodate the exchange of a higher number of packet pairs. This allows more idle time to be used by the radio and will consequently affect the radio notifications.

In peripheral links, the SoftDevice will impose a limit on how long the Radio Event ( $t_{radio}$ ) may be extended, thereby restricting the maximum number of packets exchanged to accommodate the selected  $t_{ndist}$ . The following figure shows an example where the Radio Notification  $t_{ndist}$  is limiting the extension of the first Radio Event.

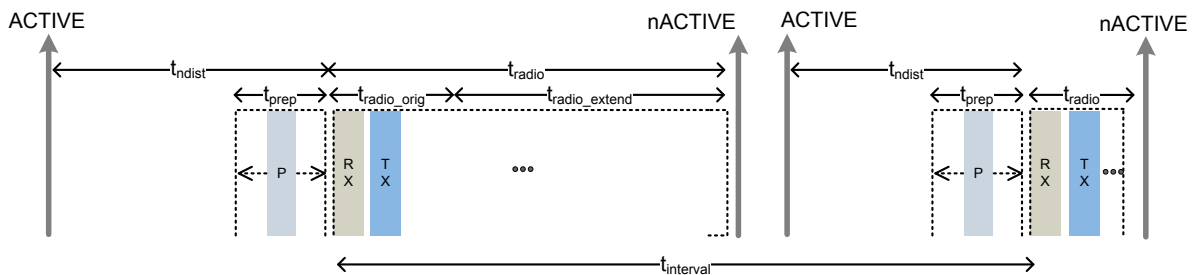

Figure 19: Peripheral connection event length extension limited by Radio Notification

In central links, Radio Notification does not impose limits on how long the Radio event ( $t_{radio}$ ) may be extended. This implies that all idle time in between connection events can be used for event extension. Because of this, the ACTIVE signal and nACTIVE signals between connection events cannot be guaranteed when Connection Event Length Extension is enabled. The following figure shows an example of how the idle time between connection events can be utilized when Connection Event Length Extension and Radio Notification signals are enabled.

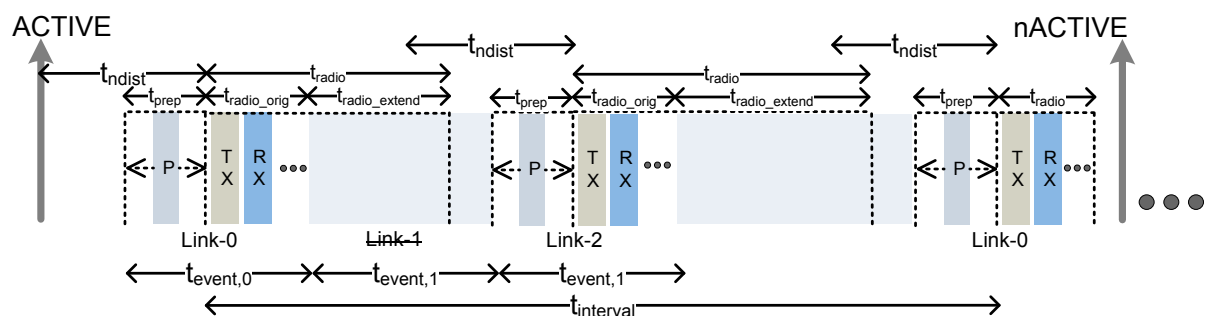

Figure 20: Connection Event Length Extension with central links

When a central and a peripheral link are running concurrently, the central connection event may be extended to utilize the available time until the start of the peripheral connection event. In case the central event ends too close to the start of the peripheral event, the notification signal before the peripheral connection event may not be available to the application. [Figure 17: Radio Event distance too short to trigger the notification signal](#) on page 60 shows an example where the time distance between the central and the peripheral events is too short to allow the SoftDevice to trigger the ACTIVE notification signal.

## 11.6 Power amplifier and low noise amplifier control configuration

The SoftDevice can be configured by the application to toggle GPIO pins before and after radio transmission and before and after radio reception to control a *PA* and/or *LNA*.

The *PA/LNA* control functionality is provided by the SoftDevice protocol stack implementation and must be enabled by the application before it can be used.

**Note:** In order to be used along with proprietary radio protocols that make use of the Timeslot API, the *PA/LNA* control functionality needs to be implemented as part of the proprietary radio protocol stack.

The *PA* and the *LNA* are controlled by one GPIO pin each. The *PA* pin is activated during radio transmission, and the *LNA* pin is activated during radio reception. The pins can be configured to be active low or active high. The following figure shows an example of *PA/LNA* timings where the *PA* pin is configured active high and the *LNA* pin is configured active low.

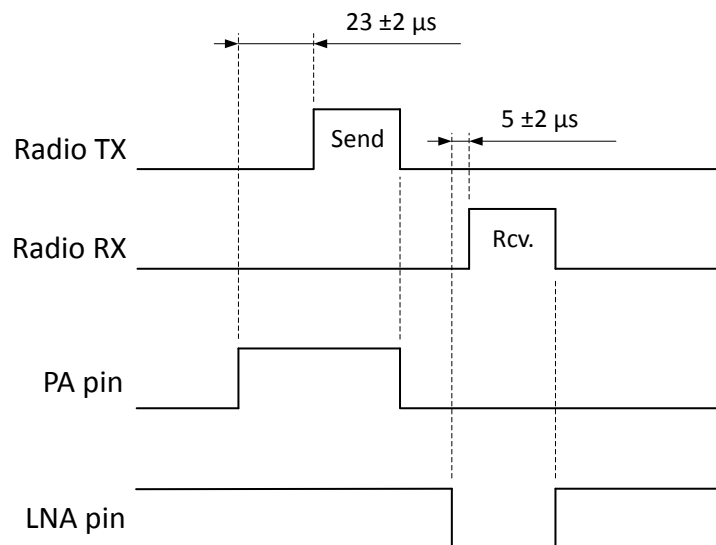

Figure 21: *PA/LNA* and radio activity timing

The SoftDevice uses a GPIOTE connected to a timer through a *PPI* channel to set the *PA* and *LNA* pins to active before the `EVENTS_READY` signal of the RADIO. The *PA* pin is set active  $23 \pm 2 \mu\text{s}$  before `EVENTS_READY` for TX, and the *LNA* pin is set active  $5 \pm 2 \mu\text{s}$  before `EVENTS_READY` for RX. The pins are restored to inactive state using a *PPI* connected to the `EVENTS_DISABLED` event on the RADIO. See the relevant product specification ([Table 1: S132 SoftDevice core documentation](#) on page 14) for more details on the nRF52 RADIO notification signals.

# 12 Master boot record and bootloader

The SoftDevice supports the use of a bootloader. A bootloader may be used to update the firmware on the SoC.

The nRF52 software architecture includes a MBR (see [Figure 1: SoC application with the SoftDevice](#) on page 15). The MBR is necessary for the bootloader to update the SoftDevice, or to update the bootloader itself. The MBR is a required component in the system. The inclusion of a bootloader is optional.

## 12.1 Master boot record

The main functionality of the MBR is to provide an interface to allow in-system updates of the application, the SoftDevice, and bootloader firmware.

The MBR module occupies a defined region in the SoC program memory where the System Vector table resides.

All exceptions (reset, hard fault, interrupts, *SVC*) are first processed by the MBR and then are forwarded to the appropriate handlers (for example the bootloader or the SoftDevice exception handlers). For more information on the interrupt forwarding scheme, see [Interrupt model and processor availability](#) on page 85.

During a firmware update process, the MBR is never erased. The MBR ensures that the bootloader can recover from any unexpected resets during an ongoing update process.

To issue the `SD_MBR_COMMAND_COPY_BL` or `SD_MBR_COMMAND_VECTOR_TABLE_BASE_SET` commands to the MBR, the `UICR.NRFFW[1]` register must be set to an address (see [MBRPARAMADDR](#) address in [Figure 22: MBR, SoftDevice, and bootloader architecture](#) on page 64) corresponding to a page in the Application Flash Region (see [Memory isolation and runtime protection](#) on page 20). If `UICR.NRFFW[1]` is not set, the commands will return `NRF_ERROR_NO_MEM`. This page will be cleared by the MBR and used to store parameters before chip reset. When the `UICR.NRFFW[1]` register is set, the page it refers to must not be used by the application. If the application does not want to reserve a page for the MBR parameters, it must leave the `UICR.NRFFW[1]` register to `0xFFFFFFFF` (its default value).

## 12.2 Bootloader

A bootloader may be used to handle in-system update procedures.

The bootloader has full access to the SoftDevice *API* and can be implemented like any application that uses the SoftDevice. In particular, the bootloader can make use of the SoftDevice *API* for *Bluetooth* Low Energy communication.

The bootloader is supported in the SoftDevice architecture by using a configurable base address for the bootloader in the application Flash Region. The base address (`BOOTLOADERADDR`) is configured by setting the `UICR.NRFFW[0]` register. The bootloader is responsible for determining the start address of the application. It uses `sd_softdevice_vector_table_base_set(uint32_t address)` to tell the SoftDevice where the application starts.

The bootloader is also responsible for keeping track of and verifying the integrity of the firmware, including SoftDevice, the application, and the bootloader itself. If an unexpected reset occurs during a firmware update, the bootloader is responsible for detecting it and resuming the update procedure.

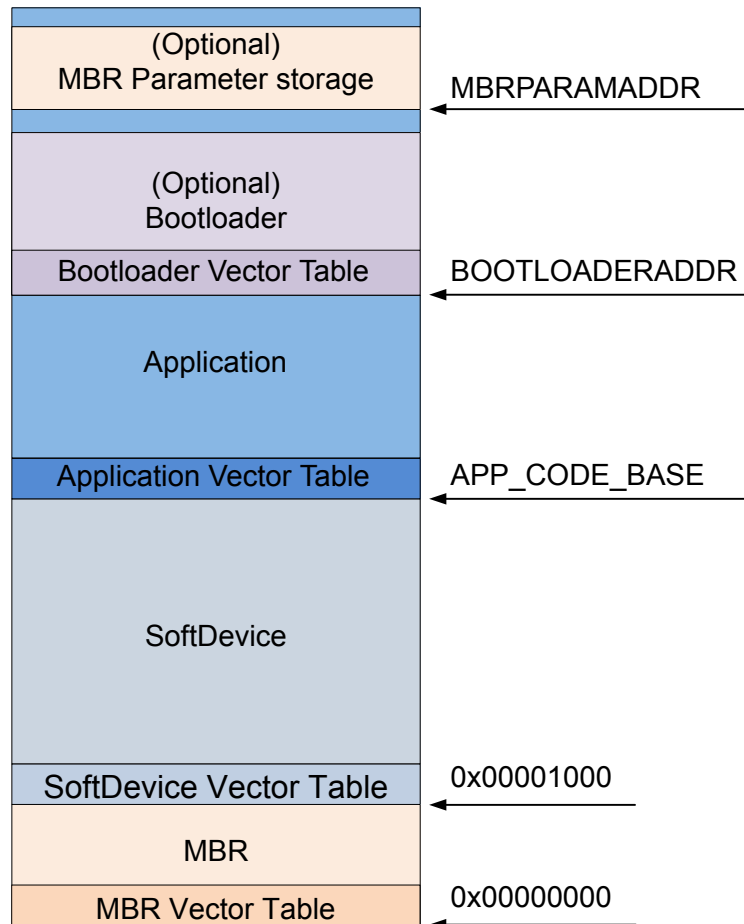

Figure 22: MBR, SoftDevice, and bootloader architecture

## 12.3 Master boot record and SoftDevice reset procedure

Upon system reset, execution branches to the MBR Reset Handler as specified in the System Vector Table.

The MBR and SoftDevice reset behavior is as follows:

- If an in-system bootloader update procedure is in progress:
  - The in-system update procedure continues its execution.
  - System resets.
- Else if `SD_MBR_COMMAND_VECTOR_TABLE_BASE_SET` has been called previously:
  - Forward interrupts to the address specified in the `sd_mbr_command_vector_table_base_set_t` parameter of the `SD_MBR_COMMAND_VECTOR_TABLE_BASE_SET` command.
  - Run from Reset Handler (defined in the vector table which is passed as command parameter).
- Else if a bootloader is present:
  - Forward interrupts to the bootloader.
  - Run Bootloader Reset Handler (defined in bootloader Vector Table at `BOOTLOADERADDR`).
- Else if a SoftDevice is present:
  - Forward interrupts to the SoftDevice.
  - Execute the SoftDevice Reset Handler (defined in SoftDevice Vector Table at `0x00001000`).



- In this case, `APP_CODE_BASE` is hardcoded inside the SoftDevice.
- The SoftDevice invokes the Application Reset Handler (as specified in the Application Vector Table at `APP_CODE_BASE`).
- Else system startup error:
  - Sleep forever.

## 12.4 Master boot record and SoftDevice initialization procedure

The SoftDevice can be enabled by the bootloader.

The bootloader can enable the SoftDevice by using the following procedure:

1. Issuing a command for MBR to forward interrupts to the SoftDevice using `sd_mbr_command()` with `SD_MBR_COMMAND_INIT_SD`.
2. Issuing a command for the SoftDevice to forward interrupts to the bootloader using `sd_softdevice_vector_table_base_set(uint32_t address)` with `BOOTLOADERADDR` as parameter.
3. Enabling the SoftDevice using `sd_softdevice_enable()`.

The bootloader can transfer the execution from itself to the application by using the following procedure:

1. Issuing a command for MBR to forward interrupts to the SoftDevice using `sd_mbr_command()` with `SD_MBR_COMMAND_INIT_SD`, if interrupts are not forwarded to the SoftDevice.
2. Issuing `sd_softdevice_disable()`, to ensure that the SoftDevice is disabled.
3. Issuing a command for the SoftDevice to forward interrupts to the application using `sd_softdevice_vector_table_base_set(uint32_t address)` with `APP_CODE_BASE` as a parameter.
4. Branching to the application Reset Handler as specified in the Application Vector Table.

# 13 SoftDevice information structure

The SoftDevice binary file contains an information structure.

The structure is illustrated in [Figure 23: SoftDevice information structure](#) on page 66. The location of the structure and the contents of various structure fields can be obtained at run time by the application using macros defined in the `nrf_sdm.h` header file. The information structure can also be accessed by parsing the binary SoftDevice file.

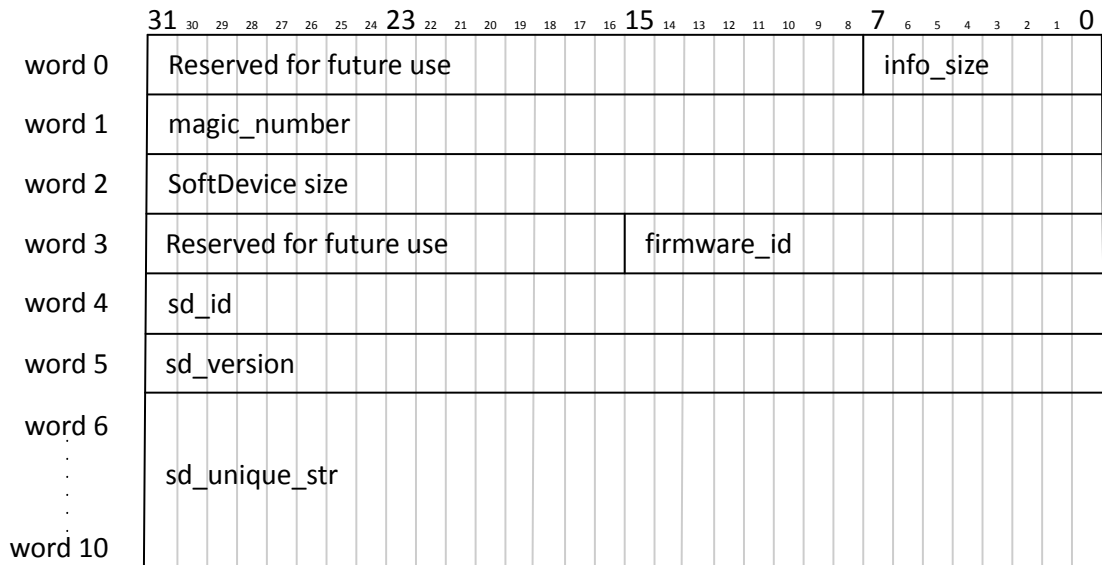

Figure 23: SoftDevice information structure

The SoftDevice release is identified by the Firmware ID, located in `firmware_id`, and the code revision, located in `sd_unique_str`. A unique Firmware ID is assigned to each production and beta release. Alpha and prealpha releases usually have a firmware ID set to `0xFFFE`. The code revision in `sd_unique_str` is the git hash from which the SoftDevice is built.

# 14 SoftDevice memory usage

The SoftDevice shares the available flash memory and RAM on the nRF52 SoC with the application. The application must therefore be aware of the memory resources needed by the SoftDevice and leave the parts of the memory used by the SoftDevice undisturbed for correct SoftDevice operation.

The SoftDevice requires a fixed amount of flash memory and RAM, which are detailed in [Memory resource requirements](#) on page 68. In addition, depending on the runtime configuration, the SoftDevice will require:

- Additional RAM for *Bluetooth* Low Energy roles and bandwidth (see [Role configuration](#) on page 70)
- Attributes (see [Attribute table size](#) on page 69)
- Security (see [Security configuration](#) on page 70)
- UUID storage (see [Vendor specific UUID counts](#) on page 70)

## 14.1 Memory resource map and usage

The memory map for program memory and RAM when the SoftDevice is enabled is described in this section.

[Figure 24: Memory resource map](#) on page 68 illustrates the memory usage of the SoftDevice alongside a user application. The flash memory for the SoftDevice is always reserved, and the application program code should be placed above the SoftDevice at `APP_CODE_BASE`. The SoftDevice uses the first eight bytes of RAM when not enabled. Once enabled, the RAM usage of the SoftDevice increases. With the exception of the call stack, the RAM usage for the SoftDevice is always isolated from the application usage. Therefore, the application is required to not access the RAM region below `APP_RAM_BASE`. The value of `APP_RAM_BASE` is obtained by calling `sd_softdevice_enable`, which will always return the required minimum start address of the application RAM region for the given configuration. An access below the required minimum application RAM start address will result in undefined behavior. The RAM requirements of an enabled SoftDevice are detailed in [Table 28: S132 Memory resource requirements for RAM](#) on page 68.

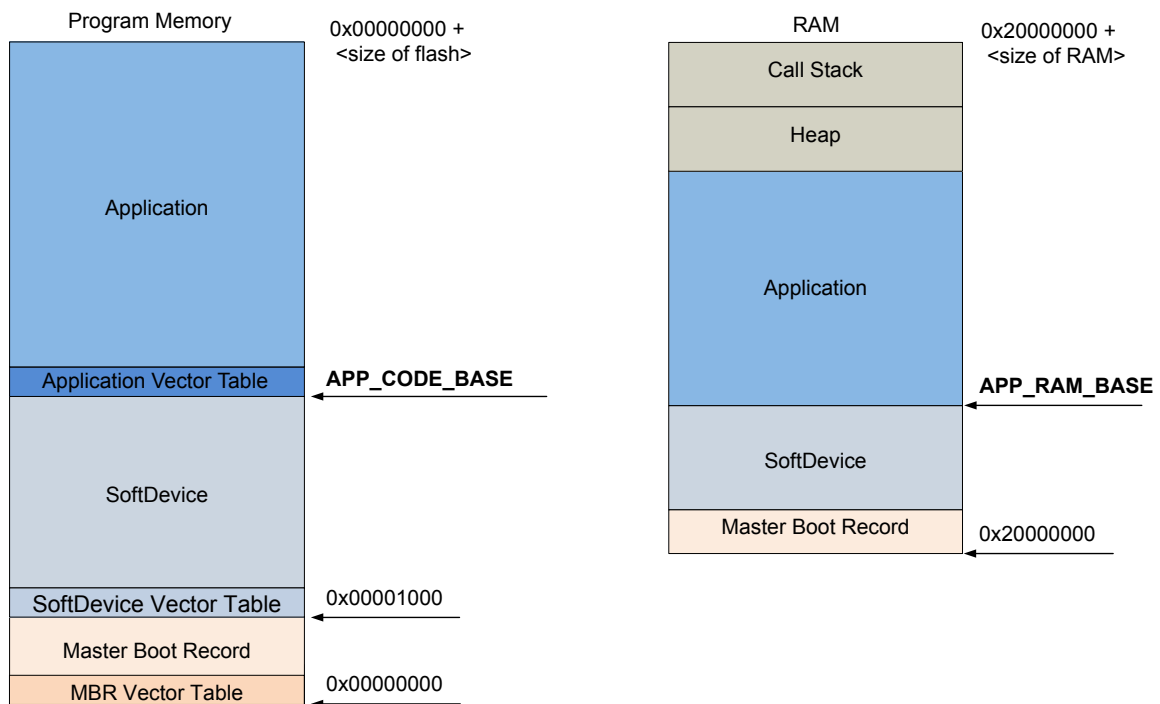

Figure 24: Memory resource map

### 14.1.1 Memory resource requirements

This section describes the memory resource requirements for an enabled and disabled S132 SoftDevice.

#### Flash

The combined flash usage of the SoftDevice and the MBR can be found in the SoftDevice properties section of the release notes. This value corresponds to `APP_CODE_BASE` in [Figure 24: Memory resource map](#) on page 68. The combined flash usage of the SoftDevice and the MBR can also be calculated by adding the MBR flash usage, which is 4 kB<sup>11</sup>, to the `SD_FLASH_SIZE` defined in `nrf_sdm.h`.

#### RAM

RAM	S132 Enabled	S132 Disabled
SoftDevice RAM consumption	Minimum required RAM <sup>12</sup> + Configurable Resources	8 bytes
APP_RAM_BASE address (minimum required value)	0x20000000 + SoftDevice RAM consumption	0x20000008

Table 28: S132 Memory resource requirements for RAM

#### Call stack

By default, the nRF52 SoC will have a shared call stack with both application stack frames and SoftDevice stack frames, managed by the *MSP*.

<sup>11</sup> 1 kB = 1024 bytes

<sup>12</sup> For the minimum RAM required by the SoftDevice, see the SoftDevice properties section of the release notes.

The application configures the call stack, and the *MSP* gets initialized on reset to the address specified by the application vector table entry 0. In its reset vector the application may configure the CPU to use the *Process Stack Pointer (PSP)* in thread mode. This configuration is optional but may be required by an OS, for example, to isolate application threads and OS context memory. The application programmer must be aware that the SoftDevice will use the *MSP* as it is always executed in exception mode.

**Note:** It is customary, but not required, to let the stack run downwards from the upper limit of the RAM Region.

With each major release of an S132 SoftDevice, its maximum (worst case) call stack requirement may be updated. The SoftDevice uses the call stack when SoftDevice interrupt handlers execute. These are asynchronous to the application, so the application programmer must reserve call stack for the application in addition to the call stack requirement by the SoftDevice.

The application must reserve sufficient space to satisfy both the application and the SoftDevice stack memory requirements. The nRF52 *SoC* has no designated hardware for detecting stack overflow. The application can use the *Memory Watch Unit (MWU)* peripheral to implement a mechanism for stack overflow detection.

The SoftDevice does not use the ARM Cortex-M4 *Floating-Point Unit (FPU)* and does not configure any floating-point registers. [Table 29: S132 Memory resource requirements for call stack](#) on page 69 depicts the maximum call stack size that may be consumed by the SoftDevice when not using the *FPU*.

The SoftDevice uses multiple interrupt levels, as described in detail in [Interrupt model and processor availability](#) on page 85. If *FPU* is used by the application, the processor will need to reserve memory in the stack frame for stacking the *FPU* registers for each interrupt level used by the SoftDevice. This must be accounted for when configuring the total call stack size. For more information on how the use of multiple interrupt levels impacts the stack size when using the *FPU*, see [Application Note 298](#) from ARM regarding the ARM Cortex-M4 processor with *FPU*.

Call stack	S132 Enabled	S132 Disabled
Maximum usage with FPU disabled	1536 bytes (0x600)	0 bytes

Table 29: S132 Memory resource requirements for call stack

## Heap

There is no heap required by nRF52 SoftDevices. The application is free to allocate and use a heap without disrupting the SoftDevice functionality.

## 14.2 Attribute table size

The size of the attribute table can be configured through the SoftDevice *API* when enabling the *Bluetooth Low Energy* stack.

The default and minimum values of the attribute table size, `ATTR_TAB_SIZE`, can be found in `ble_gatts.h`. Applications that require an attribute table smaller or bigger than the default size can choose to either reduce or increase the attribute table size. The amount of RAM reserved by the SoftDevice and the minimum required start address for the application RAM, `APP_RAM_BASE`, will then change accordingly.

The attribute table size is set through `sd_ble_cfg_set`.

## 14.3 Role configuration

The SoftDevice allows the number of connections, the configuration of each connection, and its role to be specified by the application.

Role configuration, the number of connections, and connection configuration, will determine the amount of RAM resources used by the SoftDevice. The minimum required start address for the application RAM, `APP_RAM_BASE`, will change accordingly. See [Bluetooth Low Energy role configuration](#) on page 51 for more details on role configuration.

## 14.4 Security configuration

The SoftDevice allows the number of *SMP* instances available for all connections operating in central role to be specified by the application.

At least one *SMP* instance is needed in order to carry out *SMP* operations for central role connections, and a *SMP* instance can be shared amongst multiple central role connections. A larger number of *SMP* instances will allow multiple connections to have ongoing concurrent *SMP* operations, but this will result in increased RAM usage by the SoftDevice. The number of *SMP* instances is specified through `sd_ble_cfg_set`.

## 14.5 Vendor specific UUID counts

The SoftDevice allows the use of vendor specific UUIDs, which are stored by the SoftDevice in the RAM that is allocated once the SoftDevice is enabled.

The number of vendor specific UUIDs that can be stored by the SoftDevice is set through `sd_ble_cfg_set`.

# 15 Scheduling

The S132 stack has multiple activities, called timing-activities, which require exclusive access to certain hardware resources. These timing-activities are time-multiplexed to give them the required exclusive access for a period of time. This is called a timing-event. Such timing-activities are *Bluetooth* Low Energy role events like events for Central roles and Peripheral roles, Flash memory API usage, and Radio Timeslot API timeslots.

If timing-events collide, their scheduling is determined by a priority system. If timing-activity A needs a timing-event at a time that overlaps with timing-activity B, and timing-activity A has higher priority, timing-activity A will get the timing-event. Activity B will be blocked and its timing-event will be rescheduled for a later time. If both timing-activity A and timing-activity B have the same priority, the timing-activity which was requested first will get the timing-event.

The timing-activities run to completion and cannot be preempted by other timing-activities, even if the timing-activity trying to preempt has a higher priority. This is the case, for example, when timing-activity A and timing-activity B request a timing-event at overlapping times with the same priority. Timing-activity A gets the timing-event because it requested it earlier than timing-activity B. If timing-activity B increased its priority and requested again, it would only get the timing-event if timing-activity A had not already started and there was enough time to change the timing-event schedule.

**Note:** The figures in this chapter do not illustrate all packets that are sent over the air. See [Bluetooth Core Specification](#) for the complete sequence of packets.

## 15.1 SoftDevice timing-activities and priorities

The SoftDevice supports multiple connections, an Advertiser or Broadcaster, and an Observer or Scanner simultaneously. In addition to these *Bluetooth* Low Energy roles, Flash memory API, *QoS* channel survey, and Radio Timeslot API can also run simultaneously.

Advertiser and broadcaster timing-events are scheduled as early as possible. Peripheral link timing-events follow the timings dictated by the connected peer. Central link timing-events are added relative to already running central link timing-events. Peripheral role timing-events (peripheral link timing-event, advertiser/broadcaster timing-event) and central role timing-events (central link timing-event, initiator/scanner timing-event) are scheduled independently and so may occur at the same time and collide. Similarly, Flash access timing-event and Radio Timeslot timing-event are scheduled independently and so may occur at the same time and collide. *QoS* channel survey timing-event has the lowest priority. If channel survey is running in parallel with any of the above timing-activities, the average survey interval may become longer.

The different timing-activities have different priorities at different times, dependent upon their state. As an example, if a connection as a Peripheral is about to reach supervision time-out, it will block all other timing-activities and get the timing-event it requests. In this case, all other timing-activities will be blocked if they overlap with the connection timing-event, and they will have to be rescheduled. The following table summarizes the priorities.

Priority (Decreasing order)	Role state
First priority	<ul style="list-style-type: none"> <li>• Central connections that are about to time out</li> <li>• Peripheral connection setup (waiting for ack from peer)</li> <li>• Peripheral connections that are about to time out</li> </ul>
Second priority	<ul style="list-style-type: none"> <li>• Central connection setup (waiting for ack from peer)</li> <li>• Initiator</li> <li>• Connectable advertiser/Broadcaster/Scanner which has been blocked consecutively for a few times</li> <li>• Scanner which is receiving an advertising packet on a secondary advertising channel</li> </ul>
Third priority	<ul style="list-style-type: none"> <li>• All <i>Bluetooth</i> Low Energy roles in states other than above run with this priority</li> <li>• Flash access after it has been blocked consecutively for a few times</li> <li>• Radio Timeslot with high priority</li> </ul>
Fourth priority	<ul style="list-style-type: none"> <li>• Flash access</li> <li>• Radio Timeslot with normal priority</li> </ul>
Last priority	<ul style="list-style-type: none"> <li>• <i>QoS</i> channel survey</li> </ul>

Table 30: Scheduling priorities

## 15.2 Initiator timing

This section introduces the different situations that happen with the Initiator when establishing a connection.

When establishing a connection with no other connections active, the Initiator will establish the connection in the minimum time and allocate the first central link connection event transmitWindowDelay after the connect request was sent, as shown in the following figure.

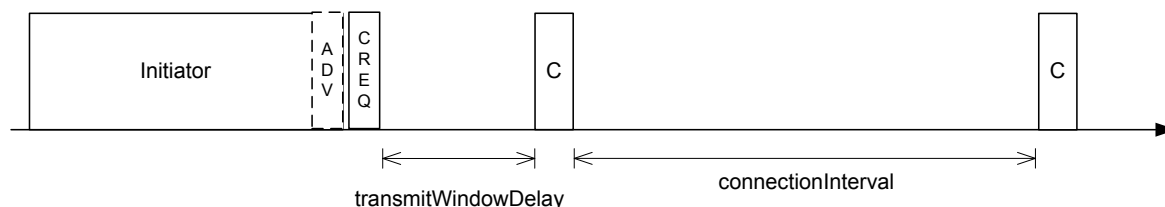

Figure 25: Initiator - first connection

When establishing a new connection with other connections already made as a Central, the Initiator will start asynchronously to the connected link timing-events and schedule the new central connection's first timing-event in any free time between existing central timing-events or after the existing central timing-events. Central link timing-events will be scheduled close to each other (without any free time between them). The minimum time between the start of two central role timing-events is the event length of



the central role to which the first timing-event belongs. This minimum time is referred to as  $t_{\text{event}}$ . The following figure illustrates the case of establishing a new central connection with one central connection already running.

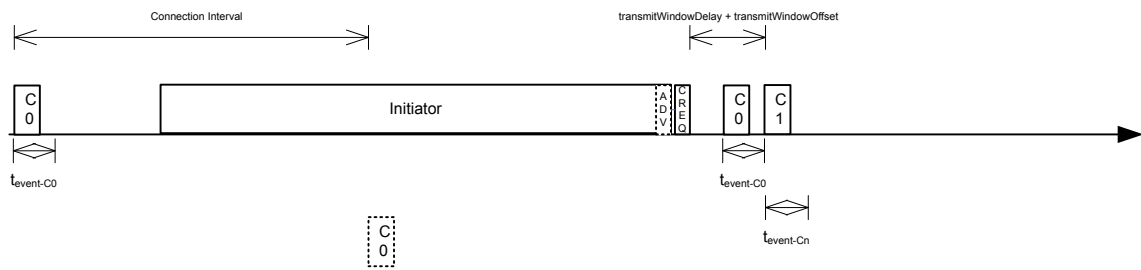

Figure 26: Initiator - one central connection running

**Note:** The Initiator is scheduled asynchronously to any other role (and any other timing-activity) and assigned higher priority to ensure faster connection setup.

When a central link disconnects, the timings of other central link timing-events remain unchanged. The following figure illustrates the case when central link C1 is disconnected, which results in free time between C0 and C2.

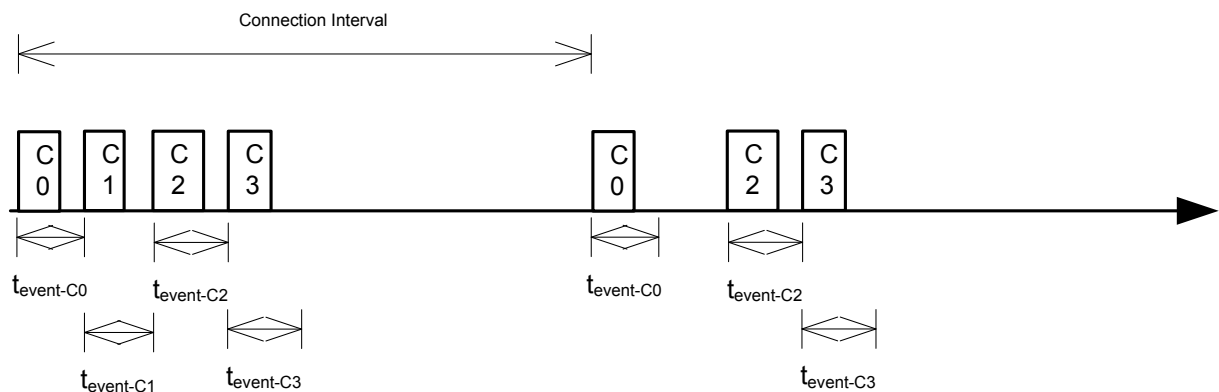

Figure 27: Initiator - free time due to disconnection

When establishing a new connection in cases where free time is available between already running central link timing-events, best-fit algorithm is used to find which free time space should be used. [Figure 28: Initiator - one or more connections as a Central](#) on page 74 illustrates the case when all existing central connections have the same connection interval and the initiator timing-event starts around the same time as the 1st central connection (C0) timing-event in the schedule. There is available time between C1–C2 and between C2–C3. A timing-event for new a connection, Cn, is scheduled in the available time between C2–C3 because that is the best fit for Cn.

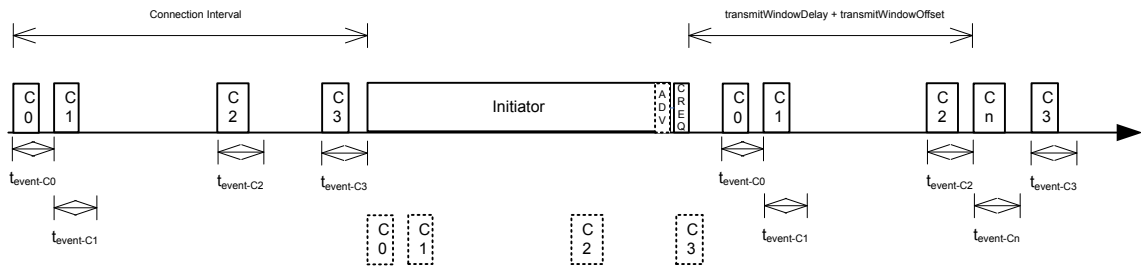

Figure 28: Initiator - one or more connections as a Central

Figure 29: Initiator - free time not enough on page 74 illustrates the case when any free time between existing central link timing-events is not long enough to fit the new connection. The new central link timing-event is placed after all running central link timing-events in this case.

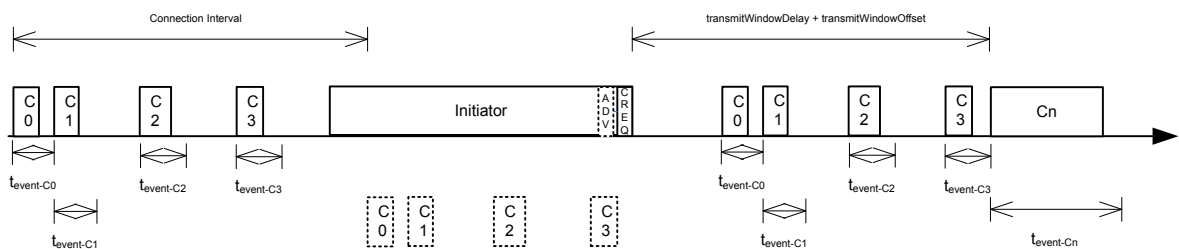

Figure 29: Initiator - free time not enough

When establishing connections to newly discovered devices, the Scanner may be used for discovery followed by the Initiator. In Figure 30: Initiator - fast connection on page 74, the Initiator is started directly after discovering a new device to connect as fast as possible to that device. The Initiator will always start asynchronously to the connected link events. The result is some link timing-events being dropped while the initiator timing-event runs. Link timing-events scheduled in the transmit window offset will not be dropped (C1). In this case, time between C0–C1 is available and is allocated for the new connection (Cn).

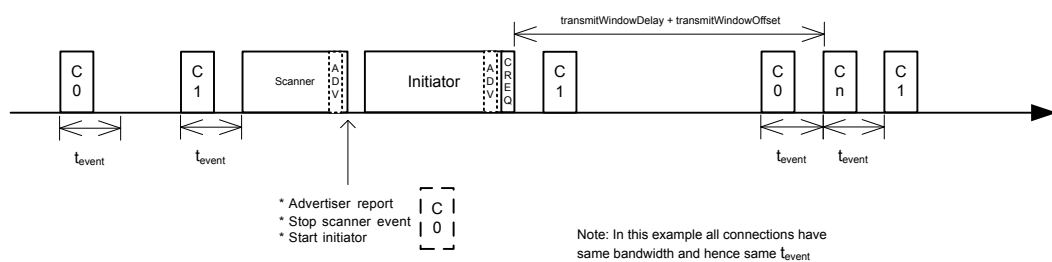

Figure 30: Initiator - fast connection

## 15.3 Connection timing as a Central

Central link timing-events are added relative to already running central link timing-events.

Central link timing-events are offset from each other by  $t_{event}$  depending on the configuration of the connection. For details about  $t_{event}$ , see [Initiator timing](#) on page 72.

Figure 31: Multilink scheduling - one or more connections as a Central, factored intervals on page 75 shows a scenario where two central links are established. C0 timing-events correspond to the first Central connection, and C1 timing-events correspond to the second Central connection. C1 timing-events are initially offset from C0 timing-events by  $t_{event-C0}$ . In this example, C1 has exactly double the connection interval of C0 (the connection intervals have a common factor which is “connectionInterval 0”), so the timing-events remain forever offset by  $t_{event-C0}$ .

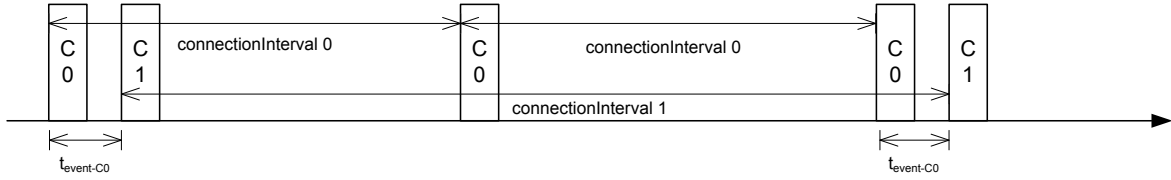

Figure 31: Multilink scheduling - one or more connections as a Central, factored intervals

In Figure 32: Multilink scheduling - one or more connections as a Central, unfactored intervals on page 75 the connection intervals do not have a common factor. This connection parameter configuration is possible, though this will result in dropped packets when events overlap. In this scenario, the second timing-event shown for C1 is dropped because it collides with the C0 timing-event.

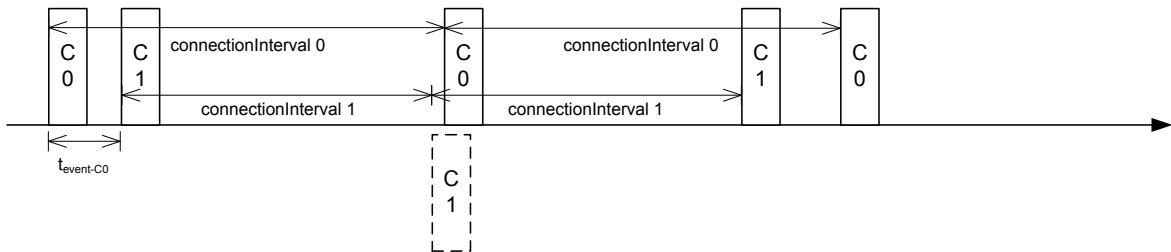

Figure 32: Multilink scheduling - one or more connections as a Central, unfactored intervals

Figure 33: Multilink scheduling with eight connections as a Central and minimum interval on page 75 shows eight concurrent links as a Central with an event length of 2.5 ms and a connection interval of 20 ms. In this case, all eight Centrals will have a connection event within the 20 ms interval, and the connection events will be 2.5 ms apart.

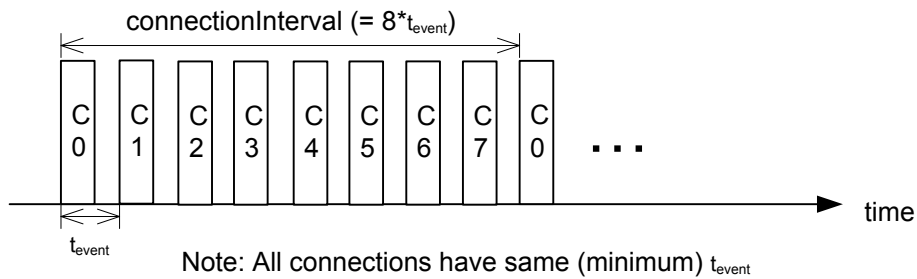

Figure 33: Multilink scheduling with eight connections as a Central and minimum interval

Figure 34: Multilink scheduling of connections as a Central and interval > min on page 76 shows a scenario similar to the one illustrated above except the connection interval is longer than 20 ms, and Central 1 and 4 has been disconnected or does not have a timing-event in this time period. It shows the idle time during a connection interval and that the timings of central link timing-events are not affected if other central links disconnect.

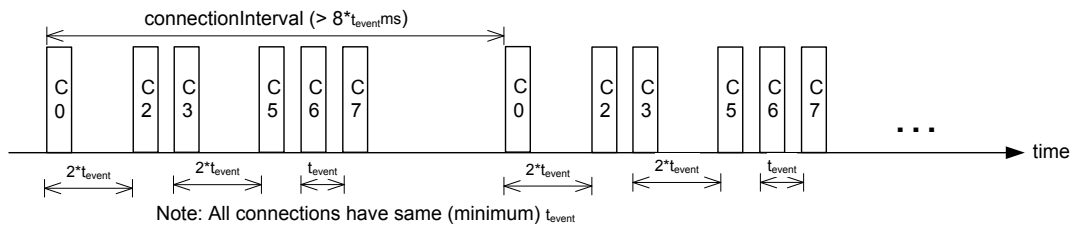

Figure 34: Multilink scheduling of connections as a Central and interval > min

## 15.4 Scanner timing

Scanning is a periodic activity where the SoftDevice listens for packets from advertisers. When the SoftDevice starts scanning, it will listen for packets on the primary advertising channels. If the SoftDevice is configured to accept extended advertising packets, and it receives a packet with a pointer to a secondary advertising channel, it will continue to scan on this channel to receive the auxiliary packet.

### 15.4.1 Primary channel scanner timing

The following figure shows that when scanning for advertisers with no active connections, the scan interval and window can be any value within the *Bluetooth Core Specification*.

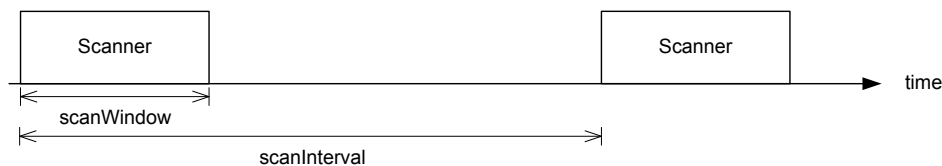

Figure 35: Scanner timing - no active connections

A primary channel scanner timing-event is always placed after the central link timing-events. Figure 36: Scanner timing - one or more connections as a Central on page 76 shows that when there are one or more active connections, the scanner or observer role timing-event will be placed after the link timing-events. With scanInterval equal to the connectionInterval and a  $scanWindow \leq (connectionInterval - (\sum t_{event-Cx} + t_{ScanReserved}))$ , scanning will proceed without overlapping with central link timing-events.

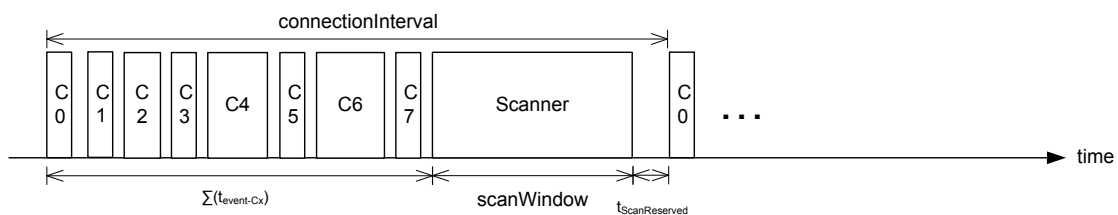

Figure 36: Scanner timing - one or more connections as a Central

The following figure shows a scenario where free time is available between link timing-events, but still the scanner timing-event is placed after all connections.

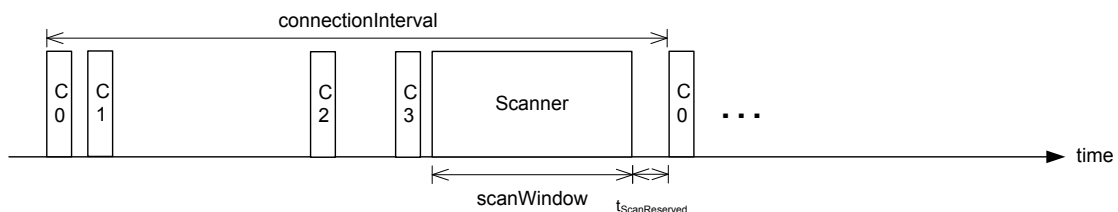

Figure 37: Scanner timing - always after connections

The following figure shows a Scanner with a long scanWindow which will cause some connection timing-events to be dropped.

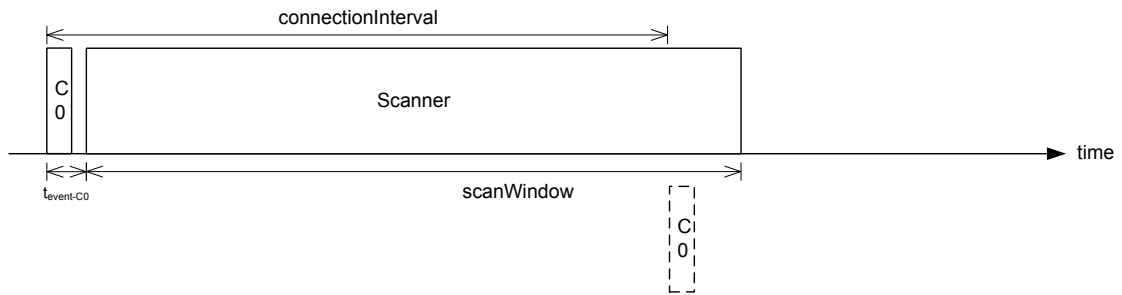

Figure 38: Scanner timing - one connection, long window

### 15.4.2 Secondary channel scanner timing

The SoftDevice will schedule a new secondary channel scanner timing-event if it receives a packet on a primary channel that points to a secondary channel or when it receives a secondary channel packet that points to another secondary packet. When the SoftDevice starts secondary channel scanning, it will pause all ongoing primary channel timing-events. It will resume primary channel scanning after it has completed all secondary channel timing-events.

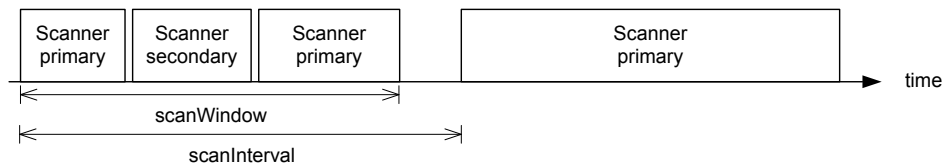

Figure 39: Scanner timing - a secondary scan timing-event pauses primary channel scanning

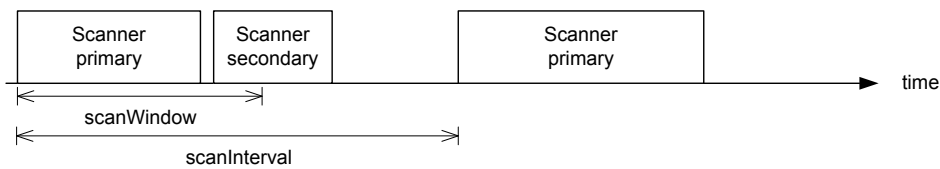

Figure 40: Scanner timing - a secondary scan timing-event does not have to fit within the scanWindow

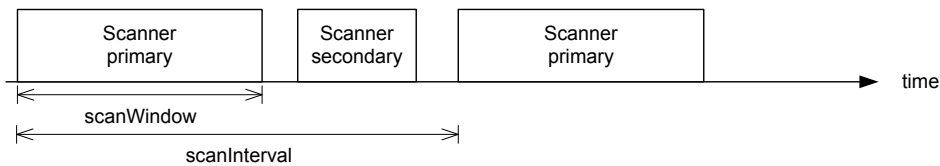

Figure 41: Scanner timing - a secondary scan timing-event may occur between two primary channel timing-events

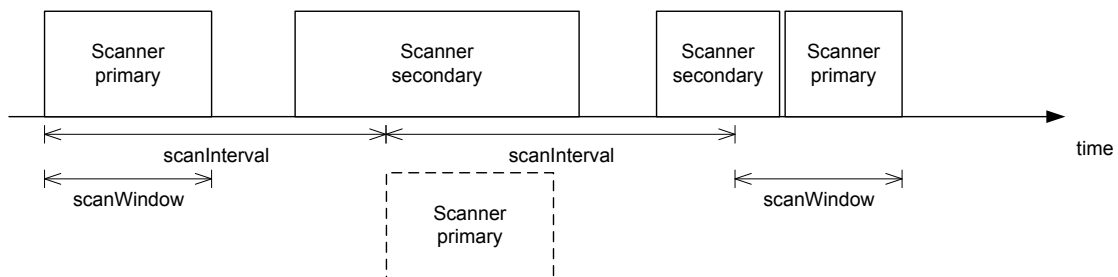

Figure 42: Scanner timing - secondary scan timing-events will pause primary channel scanning

Secondary channel timing-events may be interleaved by other timing activities. The advertiser decides when the secondary channel packets are sent. Therefore, the scanner cannot decide when the secondary scanning timing-events will occur.

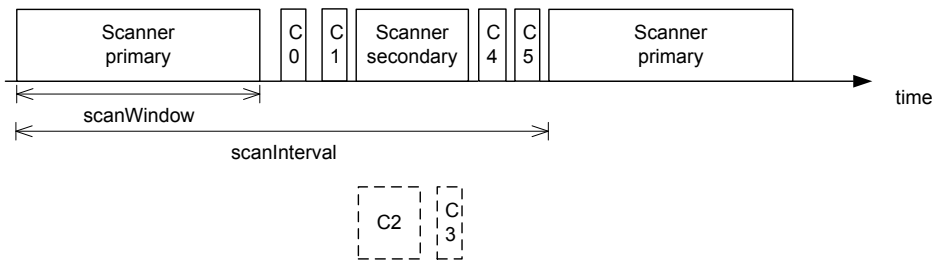

Figure 43: Scanner timing - secondary scan timing-events will interleave with connections

## 15.5 Advertiser timing

Advertiser is started as early as possible, after a random delay in the range of 3 - 13 ms, asynchronously to any other role timing-events. If no roles are running, advertiser timing-events are able to start and run without any collision.

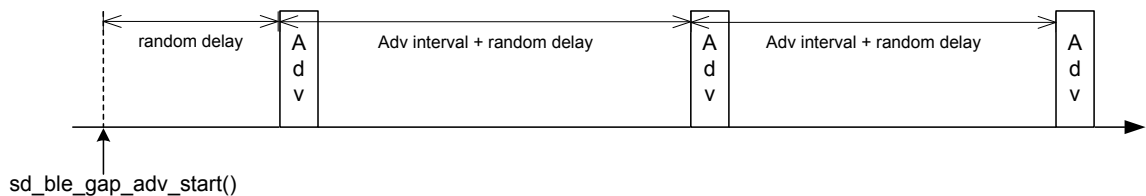

Figure 44: Advertiser

When other role timing-events are running in addition, the advertiser role timing-event may collide with those. The following figure shows a scenario of Advertiser colliding with Peripheral (P).

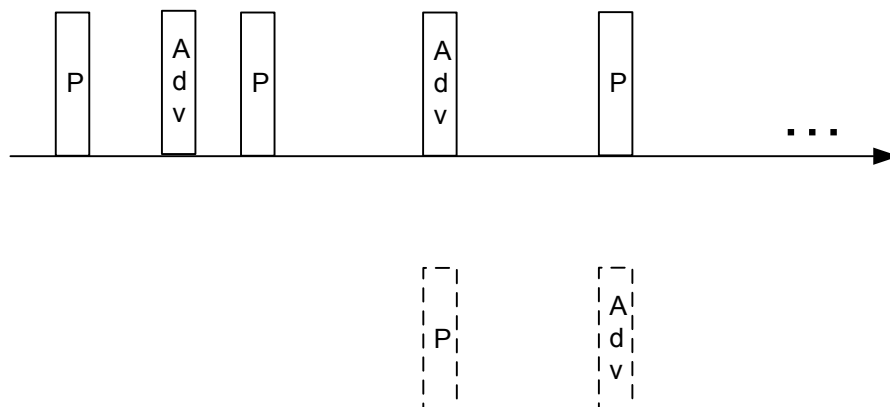

Figure 45: Advertiser collision

A directed high duty cycle advertiser is different compared to other advertiser types because it is not periodic. The scheduling of the single timing-event required by a directed advertiser is done in the same way as other advertiser type timing-events. A directed high duty cycle advertiser timing-event is also started as early as possible, and its priority (refer to [Table 30: Scheduling priorities](#) on page 72) is raised if it is blocked by other role timing-events multiple times.

Extended advertising events are scheduled as single timing-events. The events can include packets sent on both the primary and the secondary advertising channels. The duration of an extended advertising event depends on the mode, data length, and on which PHY the advertising packets are sent. The SoftDevice will send as few secondary advertising channel packets as possible with each packet containing the maximum allowed amount of data. The packets are sent with an AUX frame space of 330  $\mu$ s.

## 15.6 Peripheral connection setup and connection timing

Peripheral link timing-events are added as per the timing dictated by peer Central.

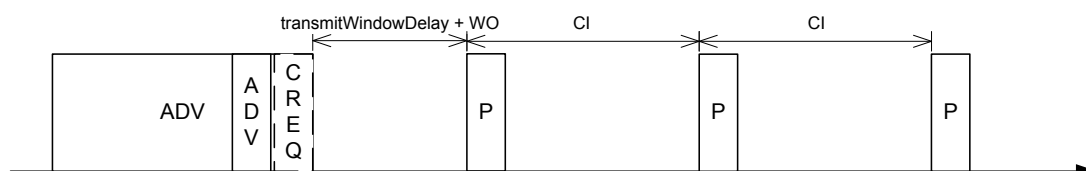

Figure 46: Peripheral connection setup and connection

Peripheral link timing-events may collide with any other running role timing-events because the timing of the connection as a Peripheral is dictated by the peer.

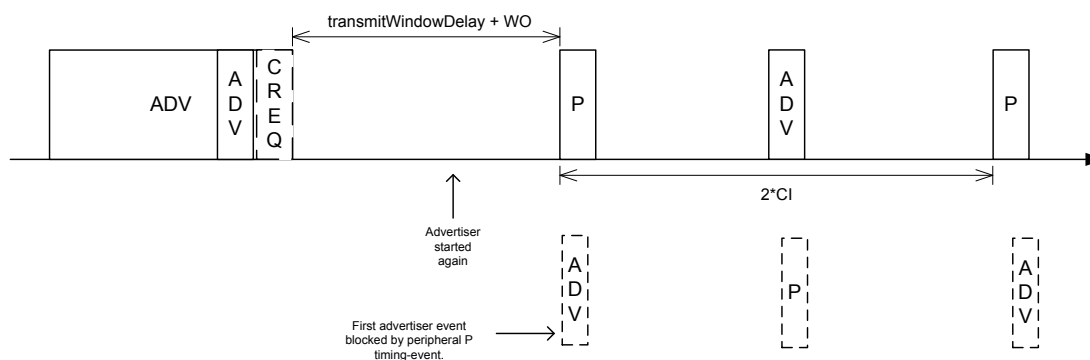

Figure 47: Peripheral connection setup and connection with collision

Value	Description	Value ( $\mu$ s)
$t_{SlaveNominalWindow}$	Listening window on slave to receive first packet in a connection event	$2 * (16 + 16 + 250 + 250)$ Assuming 250 ppm sleep clock accuracy on both slave and master with 1-second connection interval, 16 is the sleep clock instantaneous timing on both master and slave.
$t_{SlaveEventNominal}$	Nominal event length for slave link	$t_{SlaveNominalWindow} + t_{event}$ Refer to <a href="#">Table 22: Radio Notification notation and terminology</a> on page 54 and <a href="#">Table 23: Bluetooth Low Energy Radio Notification timing ranges</a> on page 55.
$t_{SlaveEventMax}$	Maximum event length for slave link	$t_{SlaveEventNominal} + 7 \text{ ms}$ Where 7 ms is added for the maximum listening window for 500 ppm sleep clock accuracy on both master and slave with 4-second connection interval. The listening window is dynamic and is therefore added so that $t_{radio}$ remains constant.
$t_{AdvEventMax}$	Maximum event length for advertiser (all types except directed high duty cycle advertiser) role	$t_{prep(max)} + t_{event(max \text{ for adv role except directed high duty cycle adv})}$ Refer to <a href="#">Table 22: Radio Notification notation and terminology</a> on page 54 and <a href="#">Table 23: Bluetooth Low Energy Radio Notification timing ranges</a> on page 55.

Table 31: Peripheral role timing ranges

## 15.7 Connection timing with Connection Event Length Extension

Central and peripheral links can extend the event if there is radio time available.

The connection event is the time within a timing-event reserved for sending or receiving packets. The SoftDevice can be enabled to dynamically extend the connection event length to fit the maximum number of packets inside the connection event before the timing-event must be ended. The time extended will be in one packet pair at a time until the maximum extend time is reached. The connection event cannot be longer than the connection interval; the connection event will then end and the next connection event will begin. A connection event cannot be extended if it will collide with another timing-event. The extend request will ignore the priorities of the timing-events.

To get the maximum bandwidth on a single link, it is recommended to enable Connection Event Length Extension and increase the connection interval. This will allow the SoftDevice to send more packets within the event and limit the overhead of processing between connection events. For more information, see [Suggested intervals and windows](#) on page 81.



Multilink scheduling with connection event length extension can increase the bandwidth for multiple links by utilizing idle time between connection events. An example of this is shown in [Figure 48: Multilink scheduling and connection event length extension](#) on page 81. Here C1 can utilize the free time left by a previously disconnected link C2, C3 has idle time as the last central link, and C0 is benefitting from having a connection interval set to half of that of C1 and C3.

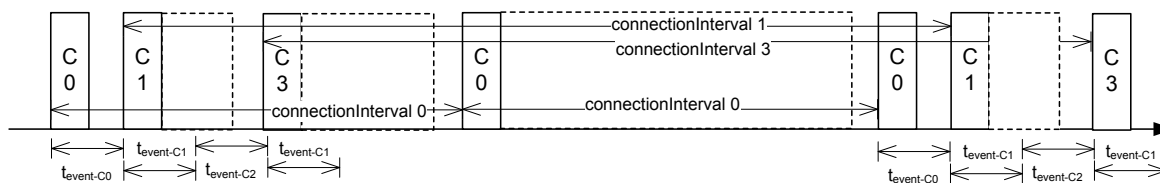

Figure 48: Multilink scheduling and connection event length extension

## 15.8 Flash API timing

Flash timing-activity is a one-time activity with no periodicity, as opposed to *Bluetooth* Low Energy role timing-activities. Hence, the flash timing-event is scheduled in any available time left between other timing-events.

To run efficiently with other timing-activities, the Flash API will run in a low priority. Other timing-activities running in higher priority can collide with flash timing-events. Refer to [Table 30: Scheduling priorities](#) on page 72 for details on priority of timing-activities, which is used in case of collision. Flash timing-activity will use higher priority if it has been blocked many times by other timing-activities. Flash timing-activity may not get a timing-event at all if other timing-events occupy most of the time and use priority higher than flash timing-activity. To avoid a long wait time while using Flash API, flash timing-activity will fail in case it cannot get a timing-event before a timeout.

## 15.9 Timeslot API timing

Radio Timeslot API timing-activity is scheduled independently of any other timing activity, hence it can collide with any other timing-activity in the SoftDevice.

Refer to [Table 30: Scheduling priorities](#) on page 72 for details on priority of timing-activities, which is used in case of collision. If the requested timing-event collides with already scheduled timing-events with equal or higher priority, the request will be denied (blocked). If a later arriving timing-activity of higher priority causes a collision, the request will be canceled. However, a timing-event that has already started cannot be interrupted or canceled.

If the timeslot is requested as *earliest possible*, Timeslot timing-event is scheduled in any available free time. Hence there is less probability of collision with *earliest possible* request. Timeslot API timing-activity has two configurable priorities. To run efficiently with other timing-activities, the Timeslot API should run in lowest possible priority. It can be configured to use higher priority if it has been blocked many times by other timing-activities and is in a critical state.

## 15.10 Suggested intervals and windows

This section provides recommendations for choosing intervals and windows for connection and scanning on LE 1M PHY unless specified otherwise.

The time required to fit one timing-event of all active central links is equal to the sum of  $t_{\text{event}}$  of all active central links. Therefore, 20 link timing-events can complete in  $\sum t_{\text{event-C}_x}$ , which is 50 ms for connections with a 2.5 ms event length.

This does not leave sufficient time in the schedule for scanning or initiating new connections (when the number of connections already established is less than the maximum). Scanner, observer, and initiator events can therefore cause connection packets to be dropped.

It is recommended that all connections have intervals that have a common factor. This common factor should be greater than or equal to  $\sum t_{event-Cx}$ . For example, for eight connections with an event length of 2.5 ms, the lowest recommended connection interval is 20 ms. This means all connections would then have a connection interval of 20 ms or a multiple of 20 ms, such as 40 ms, 60 ms, and so on.

If short connection intervals are not essential to the application and there is a need to have a Scanner running at the same time as connections, then it is possible to avoid dropping packets on any connection as a Central by having a connection interval larger than  $\sum t_{event-Cx} + scanWindow + t_{ScanReserved}$ . The Initiator is scheduled asynchronously to any other role (and any other timing-activity), hence the initiator timing-event might collide with other timing-events even if the above recommendation is followed.

For example, setting the connection interval to 43.75 ms will allow three connection events with event length of 3.75 ms and a scan window of 31.0 ms, which is sufficient to ensure advertising packets from a 20 ms (nominal) advertiser hitting and being responded to within the window.

When the SoftDevice is configured to do extended scanning, it is able to receive auxiliary packets outside of the configured scan window. Therefore, to ensure that the SoftDevice receives packets from an advertiser, the scan window should be configured to be long enough to receive three primary channel packets. For an advertiser configured with an advertising interval of 50 ms, on LE 1M PHY this corresponds to 52.5 ms.

The event length should be used together with the connection interval to set the desired bandwidth of the connection. When both peripheral and central roles are running, it is recommended to use the event length to ensure a fair allocation of the available Radio time resources between the existing roles and then enable Connection Event Length Extension to improve the bandwidth if possible.

When long LL Data Channel PDUs are in use, it is recommended to increase the event length of a connection. For example, LL Data Channel PDUs are by default 27 bytes in size. With an event length of 7.5 ms, it is possible to send seven full-sized packet pairs in one connection event. Therefore, when increasing the Link Layer Data Channel PDU size to 251 bytes, the event length should be increased to 33.75 ms. To calculate how much time should be added (in ms), use the following formula:  $((size - 27) * 8 * 2 * pairs) / 1000$ .

The same formula can be used for the Connected roles on LE 2M PHY. On LE 2M PHY, it is possible to fit eleven 27 bytes packet pairs in one connection event of 7.5 ms.

To summarize, a recommended configuration for operation without dropped packets for cases of only central roles running is that all central role intervals (i.e. connection interval, scanner/observer/initiator intervals) should have a common factor. This common factor should be greater than or equal to  $\sum t_{event-Cx} + scanWindow + t_{ScanReserved}$ .

When the SoftDevice is configured to do extended scanning, it is able to receive auxiliary packets outside its configured scan window. The Scanner uses asynchronous timing-events to receive such auxiliary packets. Therefore, in this configuration, there may be role collisions, which will result in packets being dropped.

Peripheral roles use the same time space as all other roles (including any other peripheral and central roles). Hence, a collision-free schedule cannot be guaranteed if a peripheral role is running along with any other role. A recommended configuration for having fewer colliding Peripherals is to set a short event length and enable the Connection Event Length Extension in the SoftDevice (see [Connection timing with Connection Event Length Extension](#) on page 80).

The probability of collision can be reduced (though not eliminated) if the central role link parameters are set as suggested in this section, and the following rules are applied for all roles:

- Interval of all roles have a common factor which is greater than or equal to  $\sum t_{event-Cx} + (t_{ScanReserved} + ScanWindow) + t_{SlaveEventNominal} + t_{AdvEventMax}$

**Note:**  $t_{\text{SlaveEventNominal}}$  can be used in the above equation in most cases, but should be replaced by  $t_{\text{SlaveEventMax}}$  for cases where links as a Peripheral can have worst-case sleep clock accuracy and longer connection interval.

- Broadcaster and advertiser roles also follow the constraint that their intervals can be factored by the smallest connection interval.

**Note:** Directed high-duty cycle advertiser is not considered here because it is not a periodic event.

If only *Bluetooth* Low Energy role events are running and the above conditions are met, the worst-case collision scenario will be Broadcaster, one or more connections as Peripheral, Initiator, and one or more connections as Central colliding in time. The number of colliding connections as Central depends on the maximum timing-event length of other asynchronous timing-activities. For example, there will be two Central connection collisions if all connections have the same bandwidth and both the initiator scan window and the  $t_{\text{event}}$  for the Broadcaster are approximately equal to the  $t_{\text{event}}$  of the Central connections. The following figure shows this case of collision.

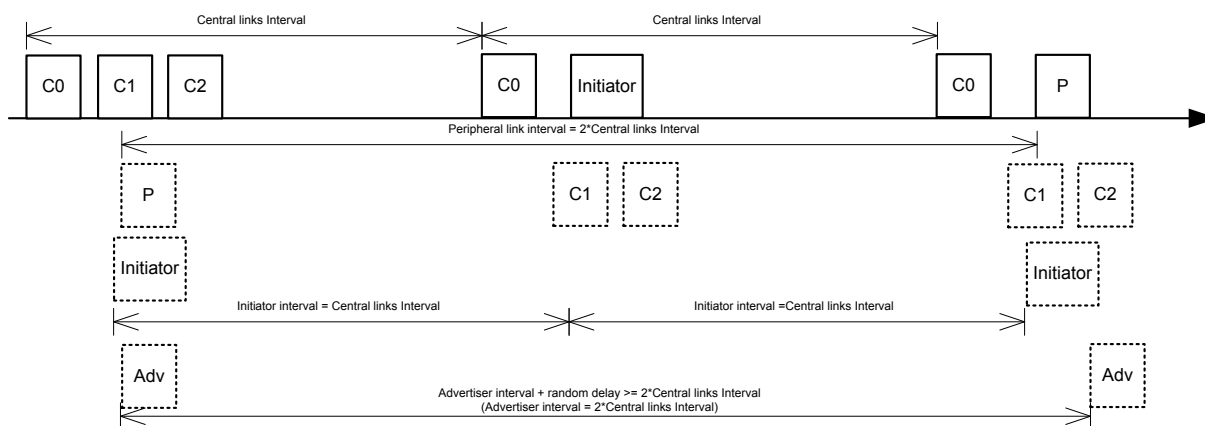

Figure 49: Worst-case collision of Bluetooth Low Energy roles

These collisions will result in collision resolution through the priority mechanism. The worst-case collision will be reduced if any of the above roles are not running. For example, when only Central and Peripheral connections are running, in the worst case each role will get a timing event 50% of the time because they have the same priority. (Refer to [Table 30: Scheduling priorities](#) on page 72). [Figure 50: Three links running as a Central and one Peripheral](#) on page 84 shows this case of collision.

Collision resolution may cause bad performance if suboptimal intervals are chosen. For example, a scanner that is configured with a scan interval of 2000 ms and a scan window of 1000 ms will collide with an advertiser with an advertising interval of 50 ms. In this case, the advertiser that schedules events often compared to the scanner will raise its priority and may cause the scanner to receive less radio time than expected.

**Note:** These are worst-case collision numbers, and an average case will most likely be better.

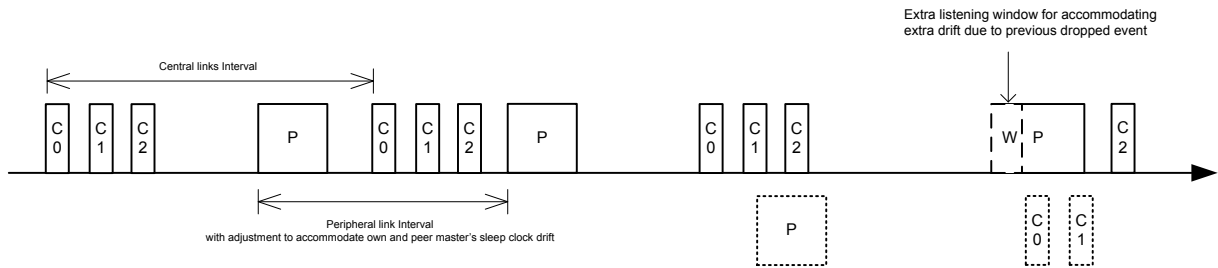

Figure 50: Three links running as a Central and one Peripheral

Timing-activities other than *Bluetooth* Low Energy role events, such as Flash access and Radio Timeslot API, also use the same time space as all other timing-activities. Hence, they will also add up to the worst-case collision scenario.

Dropped packets are possible due to collision between different roles as explained above. Application should tolerate dropped packets by setting the supervision time-out for connections long enough to avoid loss of connection when packets are dropped. For example, in a case where only three central connections and one peripheral connection are running, in the worst case, each role will get a timing-event 50% of the time. To accommodate this packet drop, the application should set the supervision time-out to twice the size it would have set if only either central or peripheral role was running.

# 16 Interrupt model and processor availability

This chapter documents the SoftDevice interrupt model, how interrupts are forwarded to the application, and describes how long the processor is used by the SoftDevice in different priority levels.

## 16.1 Exception model

As the SoftDevice, including the MBR, needs to handle some interrupts, all interrupts are routed through the MBR and SoftDevice. The ones that should be handled by the application are forwarded and the rest are handled within the SoftDevice itself. This section describes the interrupt forwarding mechanism.

For more information on the MBR, see [Master boot record and bootloader](#) on page 63.

### 16.1.1 Interrupt forwarding to the application

The forwarding of interrupts to the application depends on the state of the SoftDevice.

At the lowest level, the MBR receives all interrupts and forwards them to the SoftDevice regardless of whether the SoftDevice is enabled or not. The use of a bootloader introduces some exceptions to this. See [Master boot record and bootloader](#) on page 63.

Some peripherals and their respective interrupt numbers are reserved for use by the SoftDevice (see [Hardware peripherals](#) on page 25). Any interrupt handler defined by the application for these interrupts will not be called as long as the SoftDevice is enabled. When the SoftDevice is disabled, these interrupts will be forwarded to the application.

The *SVC* interrupt is always intercepted by the SoftDevice regardless of whether it is enabled or disabled. The SoftDevice inspects the *SVC* number, and if it is equal or greater than 0x10, the interrupt is processed by the SoftDevice. *SVC* numbers below 0x10 are forwarded to the application's *SVC* interrupt handler. This allows the application to make use of a range of *SVC* numbers for its own purpose, for example, for an RTOS.

Interrupts not used by the SoftDevice are always forwarded to the application.

For the SoftDevice to locate the application interrupt vectors, the application must define its interrupt vector table at the bottom of the Application Flash Region illustrated in [Figure 24: Memory resource map](#) on page 68. When the base address of the application code is directly after the top address of the SoftDevice, the code can be developed as a standard ARM Cortex -M4 application project with the compiler creating the interrupt vector table.

### 16.1.2 Interrupt latency due to System on Chip framework

Latency, additional to ARM Cortex -M4 hardware architecture latency, is introduced by SoftDevice logic to manage interrupt events.

This latency occurs when an interrupt is forwarded to the application from the SoftDevice and is part of the minimum latency for each application interrupt. This is the latency added by the interrupt forwarding latency alone. The maximum application interrupt latency is dependent on SoftDevice activity, as described in section [Processor usage patterns and availability](#) on page 88.

Interrupt	SoftDevice enabled	SoftDevice disabled
Open peripheral interrupt	< 3 $\mu$ s	< 1 $\mu$ s
Blocked or restricted peripheral interrupt (only forwarded when SoftDevice disabled)	N/A	< 2 $\mu$ s
Application SVC interrupt	< 2 $\mu$ s	< 2 $\mu$ s

Table 32: Additional latency due to SoftDevice and MBR forwarding interrupts

## 16.2 Interrupt priority levels

This section gives an overview of interrupt levels used by the SoftDevice and the interrupt levels that are available for the application.

To implement the SoftDevice *API* as *SVCs* (see [Application programming interface](#) on page 17) and ensure that embedded protocol real-time requirements are met independently of the application processing, the SoftDevice implements an interrupt model where application interrupts and SoftDevice interrupts are interwoven. This model will result in application interrupts being postponed or preempted, leading to longer perceived application interrupt latency and interrupt execution times.

The application must take care to select the correct interrupt priorities for application events according to the guidelines that follow. The NVIC *API* to the *SoC* Library supports safe configuration of interrupt priorities from the application.

The nRF52 *SoC* has eight configurable interrupt priorities ranging from 0 to 7 (with 0 being highest priority). On reset, all interrupts are configured with the highest priority (0).

The SoftDevice reserves and uses the following priority levels, which must remain unused by the application programmer:

- Level 0 is used for the SoftDevice's timing critical processing.
- Level 1 is used for handling the memory isolation and run time protection, see [Memory isolation and runtime protection](#) on page 20.
- Level 4 is used by higher-level deferrable tasks and the *API* functions executed as SVC interrupts.

The application can use the remaining interrupt priority levels, in addition to the main, or thread, context.

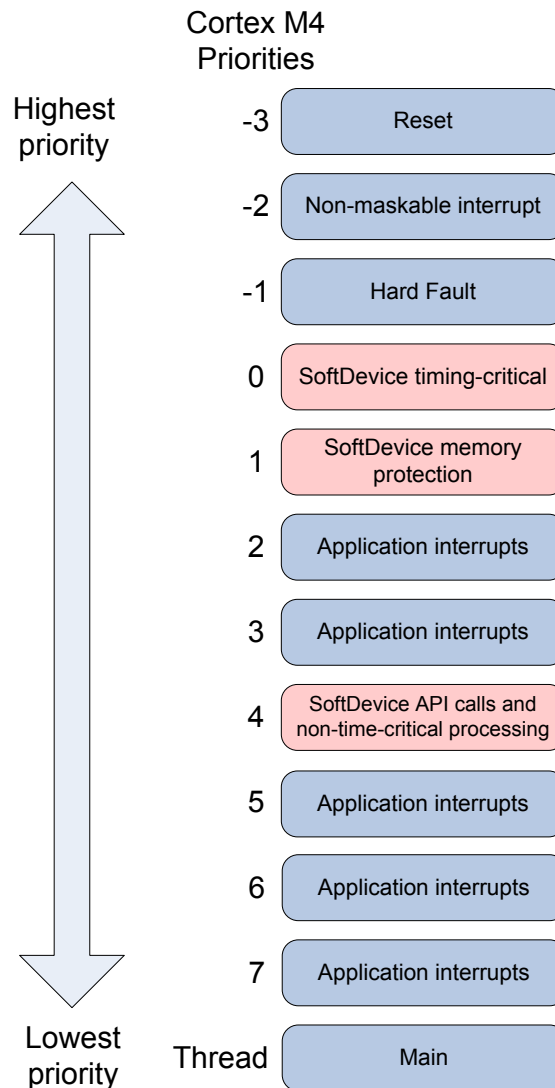

Figure 51: Exception model

As seen from [Figure 51: Exception model](#) on page 87, the application has available priority level 2 and 3, located between the higher and lower priority levels reserved by the SoftDevice. This enables a low-latency application interrupt to support fast sensor interfaces. An application interrupt at priority level 2 or 3 will only experience latency from SoftDevice interrupts at priority levels 0 and 1, while application interrupts at priority levels 5, 6, or 7 can experience latency from all SoftDevice priority levels.

**Note:** The priorities of the interrupts reserved by the SoftDevice cannot be changed. This includes the *SVC* interrupt. Handlers running at a priority level higher than 4 (lower numerical priority value) have neither access to SoftDevice functions nor to application specific *SVCs* or RTOS functions running at lower priority levels (higher numerical priority values).

The following figure shows an example of how interrupts with different priorities may run and preempt each other. Some priority levels are left out for clarity.

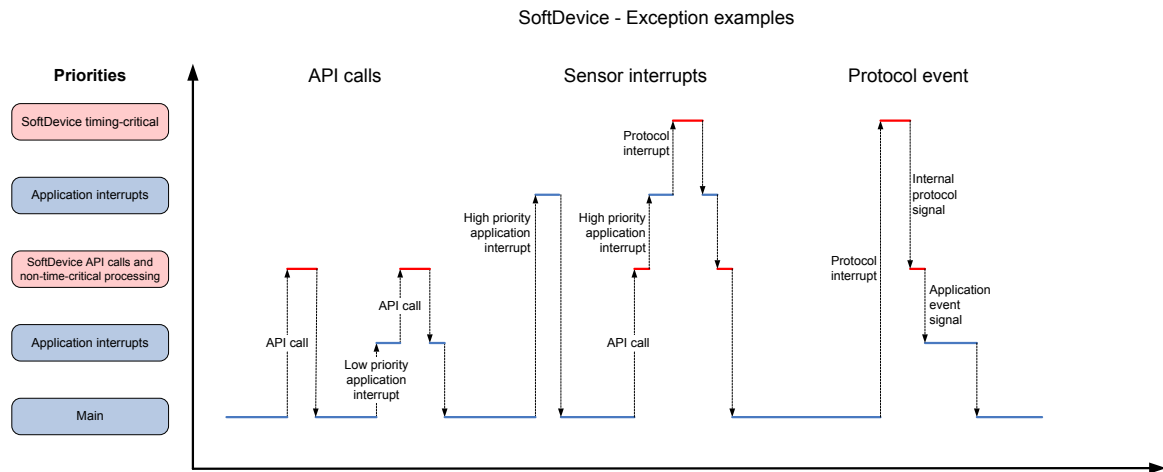

Figure 52: SoftDevice exception examples

## 16.3 Processor usage patterns and availability

This section gives an overview of the processor usage patterns for features of the SoftDevice and the processor availability to the application in stated scenarios.

The SoftDevice's processor use will also affect the maximum interrupt latency for application interrupts of lower priority (higher numerical value for the interrupt priority). The maximum interrupt processing time for the different priority levels in this chapter can be used to calculate the worst-case interrupt latency the application will have to handle when the SoftDevice is used in various scenarios.

In the following scenarios,  $t_{ISR(x)}$  denotes interrupt processing time at priority level  $x$ , and  $t_{nISR(x)}$  denotes time between interrupts at priority level  $x$ .

### 16.3.1 Flash API processor usage patterns

This section describes the processor availability and interrupt processing time for the SoftDevice when the Flash API is being used.

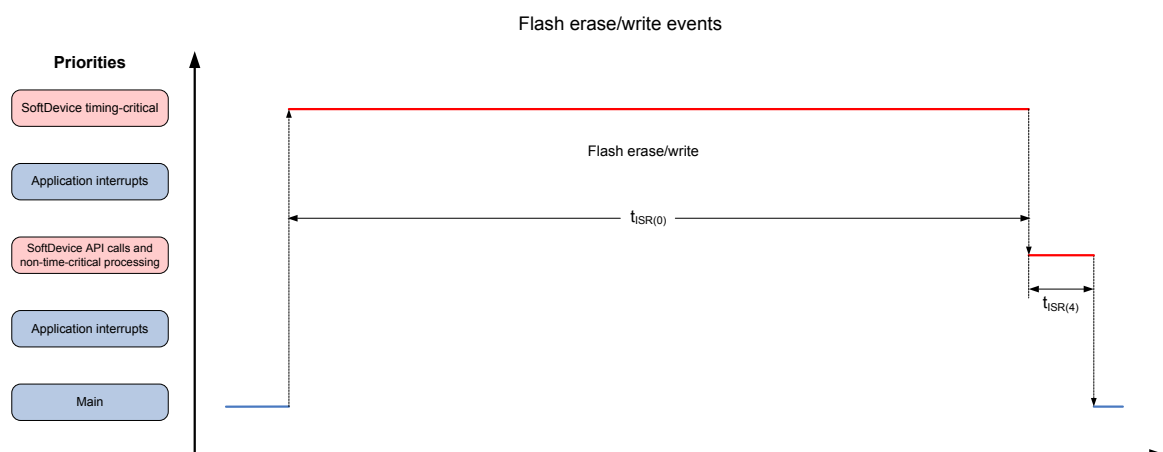

Figure 53: Flash API activity (some priority levels left out for clarity)

When using the Flash API, the pattern of SoftDevice CPU activity at interrupt priority level 0 is as follows:

1. An interrupt at priority level 0 sets up and performs the flash activity. The CPU is halted for most of the time in this interrupt.



2. After the first interrupt is complete, another interrupt at priority level 4 cleans up after the flash operation.

SoftDevice processing activity in the different priority levels during flash erase and write is outlined in the table below.

Parameter	Description	Min	Typical	Max
$t_{ISR(0),FlashErase}$	Interrupt processing when erasing a flash page. The CPU is halted most of the length of this interrupt.			90 ms
$t_{ISR(0),FlashWrite}$	Interrupt processing when writing one or more words to flash. The CPU is halted most of the length of this interrupt. The Max time provided is for writing one word. When writing more than one word, please see the Product Specification in <a href="#">Table 1: S132 SoftDevice core documentation</a> on page 14 to get the time to write one word and add it to the Max time provided in this table.			500 $\mu$ s
$t_{ISR(4)}$	Priority level 4 interrupt at the end of flash write or erase.		10 $\mu$ s	

Table 33: Processor usage for the Flash API

### 16.3.2 Radio Timeslot API processor usage patterns

This section describes the processor availability and interrupt processing time for the SoftDevice when the Radio Timeslot API is being used.

See [Radio Timeslot API](#) on page 35 for more information on the Radio Timeslot API.

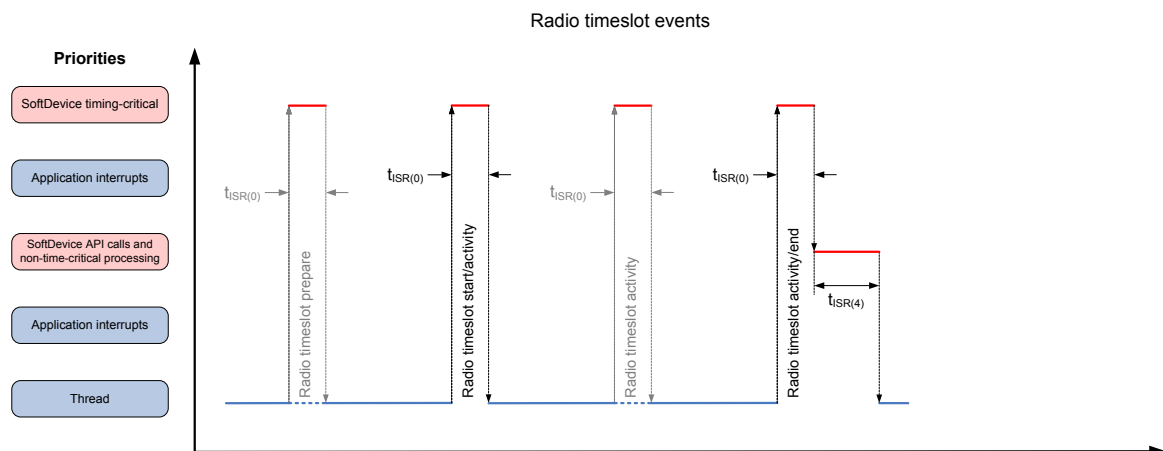

Figure 54: Radio Timeslot API activity (some priority levels left out for clarity)

When using the Radio Timeslot API, the pattern of SoftDevice CPU activity at interrupt priority level 0 is as follows:

1. If the timeslot was requested with NRF\_RADIO\_HFCLK\_CFG\_XTAL\_GUARANTEED, there is first an interrupt that handles the startup of the high-frequency crystal.
2. The interrupt is followed by one or more Radio Timeslot activities. How many and how long these are is application dependent.
3. When the last of the Radio Timeslot activities is complete, another interrupt at priority level 4 cleans up after the Radio Timeslot operation.

SoftDevice processing activity at different priority levels during use of Radio Timeslot API is outlined in the table below.

Parameter	Description	Min	Typical	Max
$t_{ISR(0),RadioTimeslotPrepare}$	Interrupt processing when starting up the high-frequency crystal			9 $\mu$ s
$t_{ISR(0),RadioTimeslotActivity}$	The application's processing in the timeslot. The length of this is application dependent.			
$t_{ISR(4)}$	Priority level 4 interrupt at the end of the timeslot		7 $\mu$ s	

Table 34: Processor usage for the Radio Timeslot API

### 16.3.3 Bluetooth Low Energy processor usage patterns

This section describes the processor availability and interrupt processing time for the SoftDevice when roles of the Bluetooth Low Energy protocol are running.

#### 16.3.3.1 Bluetooth Low Energy Advertiser (Broadcaster) processor usage

This section describes the processor availability and interrupt processing time for the SoftDevice when the advertiser (broadcaster) role is running.

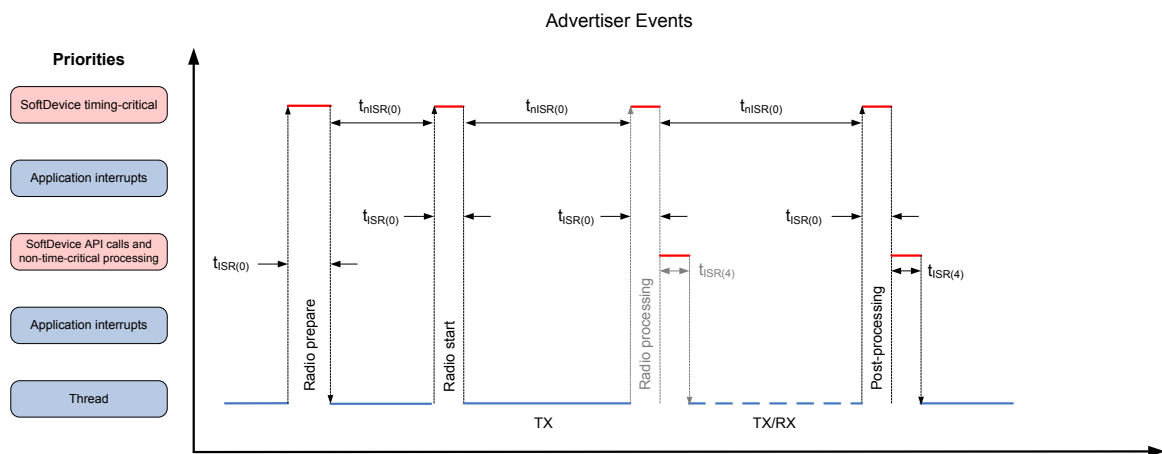

Figure 55: Advertising events (some priority levels left out for clarity)

When advertising, the pattern of SoftDevice processing activity for each advertising interval at interrupt priority level 0 is as follows:

1. An interrupt (Radio prepare) sets up and prepares the software and hardware for this advertising event.
2. A short interrupt occurs when the Radio starts sending the first advertising packet.

3. Depending on the type of advertising, there may be one or more instances of Radio processing (including processing in priority level 4) and further receptions/transmissions.
4. Advertising ends with post processing at interrupt priority level 0 and some interrupt priority level 4 activity.

SoftDevice processing activity in the different priority levels when advertising is outlined in [Table 35: Processor usage when advertising](#) on page 91. The typical case is seen when advertising without using a whitelist and without receiving scan or connect requests. The max case can be seen when advertising with a full whitelist, using private addresses, receiving scan and connect requests while having a maximum number of connections and utilizing the Radio Timeslot API, Flash memory API, using PA/LNA, and *QoS* channel survey module at the same time.

Parameter	Description	Min	Typical	Max
$t_{ISR(0),RadioPrepare}$	Processing when preparing the radio for advertising		32 $\mu$ s	50 $\mu$ s
$t_{ISR(0),RadioStart}$	Processing when starting the advertising		12 $\mu$ s	20 $\mu$ s
$t_{ISR(0),RadioProcessing}$	Processing after sending/receiving a packet		54 $\mu$ s	75 $\mu$ s
$t_{ISR(0),PostProcessing}$	Processing at the end of an advertising event		77 $\mu$ s	128 $\mu$ s
$t_{nISR(0)}$	Distance between interrupts during advertising	40 $\mu$ s	>170 $\mu$ s	
$t_{ISR(4)}$	Priority level 4 interrupt at the end of an advertising event		28 $\mu$ s	

Table 35: Processor usage when advertising

From the table we can calculate a typical processing time for one advertisement event sending three advertisement packets to be:

$$t_{ISR(0),RadioPrepare} + t_{ISR(0),RadioStart} + 2 * t_{ISR(0),RadioProcessing} + t_{ISR(0),PostProcessing} + t_{ISR(4)} = 257 \mu s$$

That means typically more than 99% of the processor time is available to the application when advertising with a 100 ms interval.

### 16.3.3.2 Bluetooth Low Energy peripheral connection processor usage

This section describes the processor availability and interrupt processing time for the SoftDevice in a peripheral connection event.

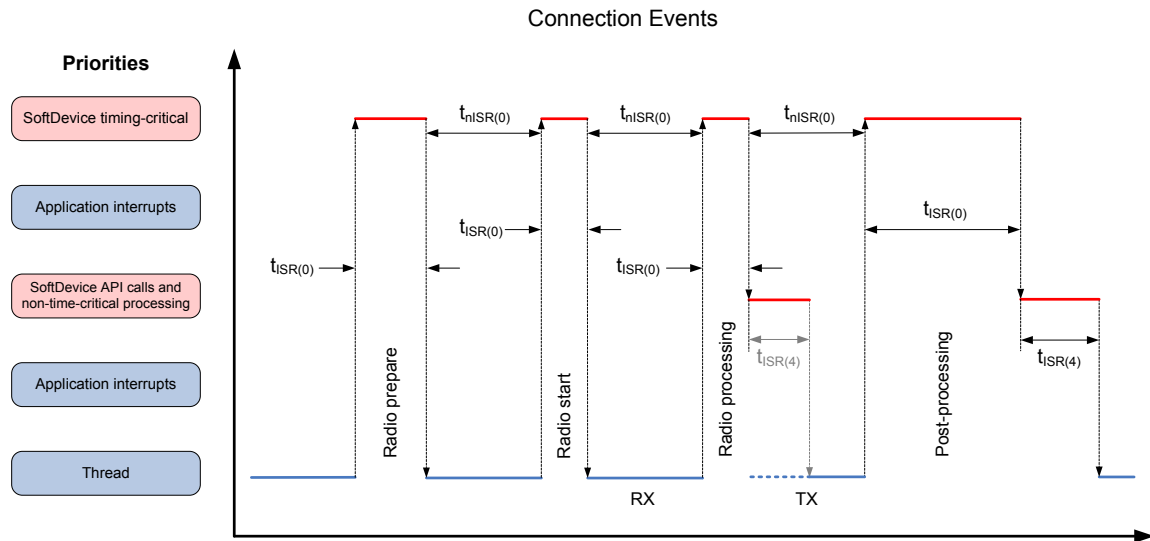

Figure 56: Peripheral connection events (some priority levels left out for clarity)

In a peripheral connection event, the pattern of SoftDevice processing activity at interrupt priority level 0 is typically as follows:

1. An interrupt (Radio prepare) sets up and prepares the software and hardware for the connection event.
2. A short interrupt occurs when the Radio starts listening for the first packet.
3. When the reception is complete, there is a radio processing interrupt that processes the received packet and switches the Radio to transmission.
4. When the transmission is complete, there is either a radio processing interrupt that switches the Radio back to reception (and possibly a new transmission after that), or the event ends with post processing.
5. After the radio and post processing in priority level 0, the SoftDevice processes any received data packets, executes any *GATT*, *ATT*, or *SMP* operations, and generates events to the application as required in priority level 4. The interrupt at this priority level is therefore highly variable based on the stack operations executed.

SoftDevice processing activity for different priority levels during peripheral connection events is outlined in [Table 36: Processor usage when connected](#) on page 93. The typical case is seen when sending *GATT* write commands writing 20 bytes. The max case can be seen when sending and receiving maximum length packets and initiating encryption, while having a maximum number of connections and utilizing the Radio Timeslot API, Flash memory API, using PA/LNA, and *QoS* channel survey module at the same time.

Parameter	Description	Min	Typical	Max
$t_{ISR(0),RadioPrepare}$	Processing when preparing the radio for a connection event		51 $\mu$ s	65 $\mu$ s
$t_{ISR(0),RadioStart}$	Processing when starting the connection event		18 $\mu$ s	24 $\mu$ s
$t_{ISR(0),RadioProcessing}$	Processing after sending or receiving a packet		60 $\mu$ s	67 $\mu$ s
$t_{ISR(0),PostProcessing}$	Processing at the end of a connection event		90 $\mu$ s	250 $\mu$ s
$t_{nISR(0)}$	Distance between interrupts during a connection event	183 $\mu$ s	> 190 $\mu$ s	
$t_{ISR(4)}$	Priority level 4 interrupt after a packet is sent or received		40 $\mu$ s	

Table 36: Processor usage when connected

From the table we can calculate a typical processing time for a peripheral connection event where one packet is sent and received to be:

$$t_{ISR(0),RadioPrepare} + t_{ISR(0),RadioStart} + t_{ISR(0),RadioProcessing} + t_{ISR(0),PostProcessing} + 2 * t_{ISR(4)} = 299 \mu s$$

That means typically more than 99% of the processor time is available to the application when one peripheral link is established and one packet is sent in each direction with a 100 ms connection interval.

### 16.3.3.3 Bluetooth Low Energy scanner and initiator processor usage

This section describes the processor availability and interrupt processing time for the SoftDevice when the scanner or initiator role is running.

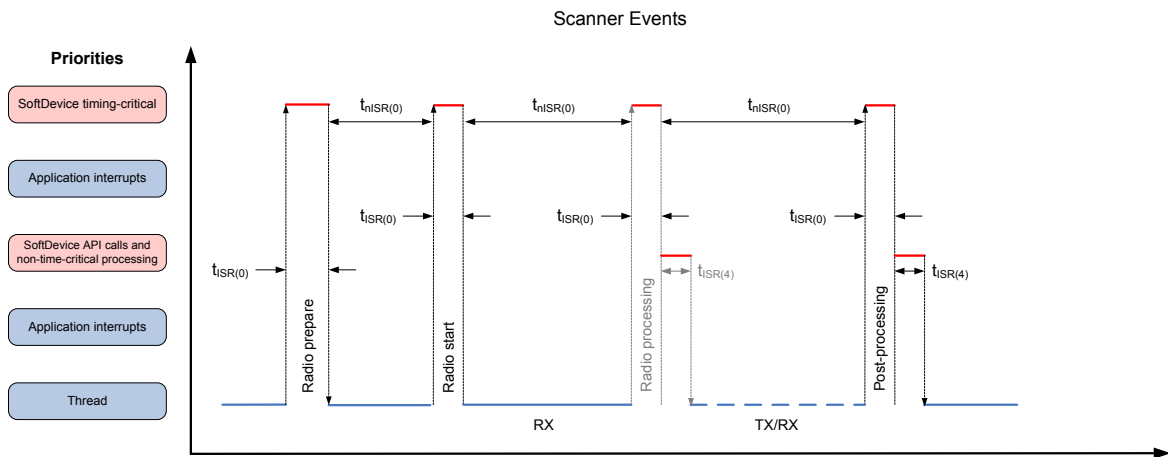

Figure 57: Scanning or initiating (some priority levels left out for clarity)

When scanning or initiating, the pattern of SoftDevice processing activity at interrupt priority level 0 is as follows:

1. An interrupt (Radio prepare) sets up and prepares the software and hardware for this scanner or initiator event.
2. A short interrupt occurs when the Radio starts listening for advertisement packets.
3. During scanning, there will be zero or more instances of radio processing, depending upon whether the active role is a Scanner or an Initiator, whether scanning is passive or active, whether advertising

packets are received or not, and upon the type of the received advertising packets. Such radio processing may be followed by the SoftDevice processing at interrupt priority level 4.

4. When the event ends (either by timeout, or if the Initiator receives a connectable advertisement packet it accepts), the SoftDevice does some Post processing, which may be followed by processing at interrupt priority level 4.

SoftDevice processing activity in the different priority levels when scanning or initiating is outlined in [Table 37: Processor usage for scanning or initiating](#) on page 94. The typical case is seen when scanning or initiating without using a whitelist and without sending scan or connect requests. The max case can be seen when scanning or initiating with a full whitelist, using private addresses, sending scan or connect requests while having a maximum number of connections, and utilizing the Radio Timeslot API, Flash memory API, using PA/LNA, and [QoS](#) channel survey module at the same time.

Parameter	Description	Min	Typical	Max
$t_{ISR(0),RadioPrepare}$	Processing when preparing the radio for scanning or initiating		32 $\mu$ s	60 $\mu$ s
$t_{ISR(0),RadioStart}$	Processing when starting the scan or initiation		20 $\mu$ s	25 $\mu$ s
$t_{ISR(0),RadioProcessing}$	Processing after sending/receiving packet		60 $\mu$ s	95 $\mu$ s
$t_{ISR(0),PostProcessing}$	Processing at the end of a scanner or initiator event		79 $\mu$ s	170 $\mu$ s
$t_{nISR(0)}$	Distance between interrupts during scanning	80 $\mu$ s	>1.5 ms	
$t_{ISR(4)}$	Priority level 4 interrupt at the end of a scanner or initiator event		27 $\mu$ s	

Table 37: Processor usage for scanning or initiating

From the table we can calculate a typical processing time for one scan event receiving one advertisement packet to be:

$$t_{ISR(0),RadioPrepare} + t_{ISR(0),RadioStart} + t_{ISR(0),RadioProcessing} + t_{ISR(0),PostProcessing} + t_{ISR(4)} = 218 \mu\text{s}$$

That means typically more than 99% of the processor time is available to the application when scanning with a 100 ms interval under these conditions.

#### 16.3.3.4 Bluetooth Low Energy central connection processor usage

This section describes the processor availability and interrupt processing time for the SoftDevice in a central connection event.

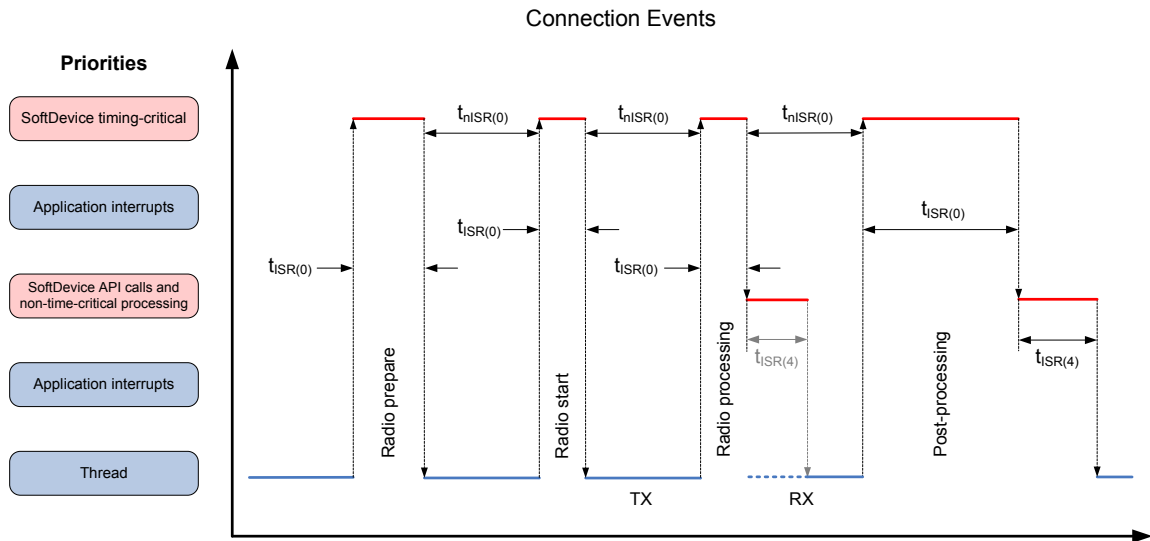

Figure 58: Central connection events (some priority levels left out for clarity)

In a central connection event, the pattern of SoftDevice processing activity at interrupt priority level 0 is typically as follows:

1. An interrupt (Radio prepare) sets up and prepares the software and hardware.
2. A short interrupt occurs when the Radio starts transmitting the first packet in the connection event.
3. When the transmission is complete, there is a radio processing interrupt that switches the Radio to reception.
4. When the reception is complete, there is a radio processing interrupt that processes the received packet and either switches the Radio back to transmission (and possibly a new reception after that), or the event ends with post processing.
5. After the priority level 0 processing, the SoftDevice processes any received data packets, executes any *GATT*, *ATT*, or *SMP* operations, and generates events to the application as required in priority level 4. The interrupt at this priority level is therefore highly variable based on the stack operations executed.

SoftDevice processing activity in the different priority levels during central connection events is outlined in [Table 38: Processor usage latency when connected](#) on page 96. The typical case is seen when receiving *GATT* write commands writing 20 bytes. The max case can be seen when sending and receiving maximum length packets and initiating encryption, while having a maximum number of connections and utilizing the Radio Timeslot API, Flash memory API, using PA/LNA, and *QoS* channel survey module at the same time.

Parameter	Description	Min	Typical	Max
$t_{ISR(0),RadioPrepare}$	Processing when preparing the radio for a connection event		29 $\mu$ s	65 $\mu$ s
$t_{ISR(0),RadioStart}$	Processing when starting the connection event		21 $\mu$ s	25 $\mu$ s
$t_{ISR(0),RadioProcessing}$	Processing after sending or receiving a packet		30 $\mu$ s	86 $\mu$ s
$t_{ISR(0),PostProcessing}$	Processing at the end of a connection event		90 $\mu$ s	170 $\mu$ s
$t_{nISR(0)}$	Distance between connection event interrupts	183 $\mu$ s	> 200 $\mu$ s	
$t_{ISR(4)}$	Priority level 4 interrupt after a packet is sent or received		40 $\mu$ s	

Table 38: Processor usage latency when connected

From the table we can calculate a typical processing time for a central connection event where one packet is sent and received to be:

$$t_{ISR(0),RadioPrepare} + t_{ISR(0),RadioStart} + t_{ISR(0),RadioProcessing} + t_{ISR(0),PostProcessing} + 2 * t_{ISR(4)} = 250 \mu s$$

This means typically more than 99% of the processor time is available to the application when one peripheral link is established and one packet is sent in each direction with a 100 ms connection interval.

### 16.3.4 Interrupt latency when using multiple modules and roles

Concurrent use of the Flash API, Radio Timeslot API, *QoS* channel survey, and/or one or more *Bluetooth* Low Energy roles can affect interrupt latency.

The same interrupt priority levels are used by all Flash API, Radio Timeslot API, and *Bluetooth* Low Energy roles. When using more than one of these concurrently, their respective events can be scheduled back-to-back (see [Scheduling](#) on page 71 for more on scheduling). In those cases, the last interrupt in the activity by one module/role can be directly followed by the first interrupt of the next activity. Therefore, to find the real worst-case interrupt latency in these cases, the application developer must add the latency of the first and last interrupt for all combinations of roles that are used.

For example, if the application uses the Radio Timeslot API while having a *Bluetooth* Low Energy advertiser running, the worst-case interrupt latency or interruption for an application interrupt is the largest of the following SoftDevice interrupts having higher priority level (lower numerical value) than the application interrupt:

- the worst-case interrupt latency of the Radio Timeslot API
- the worst-case interrupt latency of the *Bluetooth* Low Energy advertiser role
- the sum of the max time of the first interrupt of the Radio Timeslot API and the last interrupt of the *Bluetooth* Low Energy advertiser role
- the sum of the max time of the first interrupt of the *Bluetooth* Low Energy advertiser role and the last interrupt of the Radio Timeslot API



# 17 Bluetooth Low Energy data throughput

This chapter outlines achievable *Bluetooth* Low Energy connection throughput for *GATT* procedures used to send and receive data in stated SoftDevice configurations.

The throughput numbers listed in this chapter are based on measurements in an interference-free radio environment. Maximum throughput is only achievable if the application, without delay, reads data packets as they are received and provides new data as packets are transmitted. The connection event length should be set to such a value that the entire connection event can be filled with packets. The SoftDevice may transfer as many packets as can fit within the connection event as specified by the event length for the connection. For example, in simplex communication, where data is transmitted in only one direction, more time will be available for sending packets. Therefore, there may be extra TX-RX packet pairs in connection events. Additionally, more time can be made available for a connection by extending the connection events beyond their reserved time. See [Connection timing with Connection Event Length Extension](#) on page 80 for more information.

The maximum data throughput numbers given in this chapter represent the maximum amount of data that can be transferred between two applications in a given time. The maximum throughput depends on the mechanism used to transfer data. When the application utilizes ATT Handle Value Notification or ATT Write Command, the transactions are one direction only. When the application utilizes ATT Write Request, it is assumed that the peer responds with an ATT Write Response in the next connection interval. The throughput will in this case be limited to one packet every second connection interval. The amount of data in each packet is the MTU size subtracted by the ATT header size. Therefore, the throughput can be expressed as follows:

$$\text{Throughput}_{bps} = \text{num\_packets} * (\text{ATT\_MTU} - 3) * 8 / \text{seconds}$$

All data throughput values apply to packet transfers over an encrypted connection using maximum payload sizes. Maximum *LL* payload size is 27 bytes unless noted otherwise.

The following table shows maximum data throughput at a connection interval of 7.5 ms for a single peripheral or central connection.

Protocol	ATT MTU size	Event length	Method	Maximum data throughput (LE 1M PHY)	Maximum data throughput (LE 2M PHY)
GATT Client	23	7.5 ms	Receive Notification	192.0 kbps	256.0 kbps
			Send Write command	192.0 kbps	256.0 kbps
			Send Write request	10.6 kbps	10.6 kbps
			Simultaneous receive Notification and send Write command	128.0 kbps (each direction)	213.3 kbps (each direction)
GATT Server	23	7.5 ms	Send Notification	192.0 kbps	256.0 kbps
			Receive Write command	192.0 kbps	256.0 kbps
			Receive Write request	10.6 kbps	10.6 kbps

Protocol	ATT MTU size	Event length	Method	Maximum data throughput (LE 1M PHY)	Maximum data throughput (LE 2M PHY)
			Simultaneous send Notification and receive Write command	128.0 kbps (each direction)	213.3 kbps (each direction)
GATT Server	158	7.5 ms	Send Notification	248.0 kbps	330.6 kbps
			Receive Write command	248.0 kbps	330.6 kbps
			Receive Write request	82.6 kbps	82.6 kbps
			Simultaneous send Notification and receive Write command	165.3 kbps (each direction)	275.5 kbps (each direction)
GATT Client	23	3.75 ms	Receive Notification	64.0 kbps	106.6 kbps
			Send Write command	64.0 kbps	106.6 kbps
			Send Write request	10.6 kbps	10.6 kbps
			Simultaneous receive Notification and send Write command	64.0 kbps (each direction)	85.3 kbps (each direction)
GATT Server	23	3.75 ms	Send Notification	64.0 kbps	106.6 kbps
			Receive Write command	64.0 kbps	106.6 kbps
			Receive Write request	10.6 kbps	10.6 kbps
			Simultaneous send Notification and receive Write command	64.0 kbps (each direction)	85.3 kbps (each direction)
GATT Client	23	2.5 ms	Receive Notification	42.6 kbps	64.0 kbps
			Send Write command	42.6 kbps	64.0 kbps
			Send Write request	10.6 kbps	10.6 kbps
			Simultaneous receive Notification and send Write command	21.3 kbps (each direction)	42.6 kbps (each direction)
GATT Server	23	2.5 ms	Send Notification	42.6 kbps	64.0 kbps
			Receive Write command	42.6 kbps	64.0 kbps
			Receive Write request	10.6 kbps	10.6 kbps
			Simultaneous send Notification and receive Write command	21.3 kbps (each direction)	42.6 kbps (each direction)

Table 39: Data throughput for a single connection with 23 byte ATT MTU

The following table shows the maximum data throughput for a single peripheral or central connection. The event length is equal to the connection interval.

Protocol	ATT MTU size	LL payload size <sup>13</sup>	Connection interval	Method	Maximum data throughput (LE 1M PHY)	Maximum data throughput (LE 2M PHY)
GATT Server	247	251	50 ms	Send Notification	702.8 kbps	1327.5 kbps
				Receive Write command	702.8 kbps	1327.5 kbps
				Simultaneous send Notification and receive Write command	390.4 kbps (each direction)	780.8 kbps (each direction)
GATT Server	247	251	400 ms	Send Notification	771.1 kbps	1376.2 kbps
				Receive Write command	760.9 kbps	1376.2 kbps
				Simultaneous send Notification and receive Write command	424.6 (each direction)	800.4 kbps (each direction)
Raw LL data	N/A	251	400 ms	N/A	803 kbps	1447.2 kbps

Table 40: Data throughput for a single connection with 247 byte ATT MTU

A connection interval of 20 ms and an event length of 2.5 ms allows up to eight connections. The maximum throughput per connection for this case, using 23 byte ATT MTU, is shown in [Table 41: Data throughput for up to 8 connections](#) on page 100.

For connections with longer event length, a longer connection interval would need to be used for each connection to prevent connection events from overlapping. See [Scheduling](#) on page 71 for more information on how connections can be configured.

Throughput may be reduced if a peripheral link is running because peripheral links are not synchronized with central links. If a peripheral link is running, throughput may decrease to half for up to two central links and the peripheral link.

<sup>13</sup> Assuming that the peer device accepts the increased *ATT* and *LL* payload sizes.

Protocol	Event length	Method	Maximum data throughput (LE 1M PHY)
GATT Client	2.5 ms	Receive Notification	16.0 kbps
		Send Write command	16.0 kbps
		Send Write request	4.0 kbps
		Simultaneous receive Notification and send Write command	8.0 kbps (each direction)
GATT Server	2.5 ms	Send Notification	16.0 kbps
		Receive Write command	16.0 kbps
		Receive Write request	4.0 kbps
		Simultaneous send Notification and receive Write command	8.0 kbps (each direction)

Table 41: Data throughput for up to 8 connections

# 18 Bluetooth Low Energy power profiles

The power profile diagrams in this chapter give an overview of the stages within a *Bluetooth* Low Energy Radio Event implemented by the SoftDevice. The profiles illustrate battery current versus time and briefly describe the stages that could be observed.

The profiles are based on typical events with empty packets. The Standby is a state of the SoftDevice where all Peripherals are IDLE.

The time the radio spends to transmit or receive a packet depends on the PHY. Using a higher data rate will decrease the radio time, while using a lower data rate will increase the radio time. Therefore, a higher data rate decreases power consumption, while a lower data rate increases power consumption.

**Note:** A higher data rate increases throughput but reduces the link budget and therefore the maximum range. A lower data rate decreases throughput but increases the link budget.

## 18.1 Advertising event

This section gives an overview of the power profile of the advertising event implemented in the SoftDevice. [Figure 59: Advertising event](#) on page 101 shows the event current profile of an advertising event consisting of three advertising packets sent on the primary advertising channels. If the SoftDevice is configured to use extended advertising, the SoftDevice will in addition transmit one or more auxiliary advertising packets on a secondary advertising channel. For each auxiliary packet, the current profile of stage D, E, F and H in [Figure 59: Advertising event](#) on page 101 is added to the event current profile.

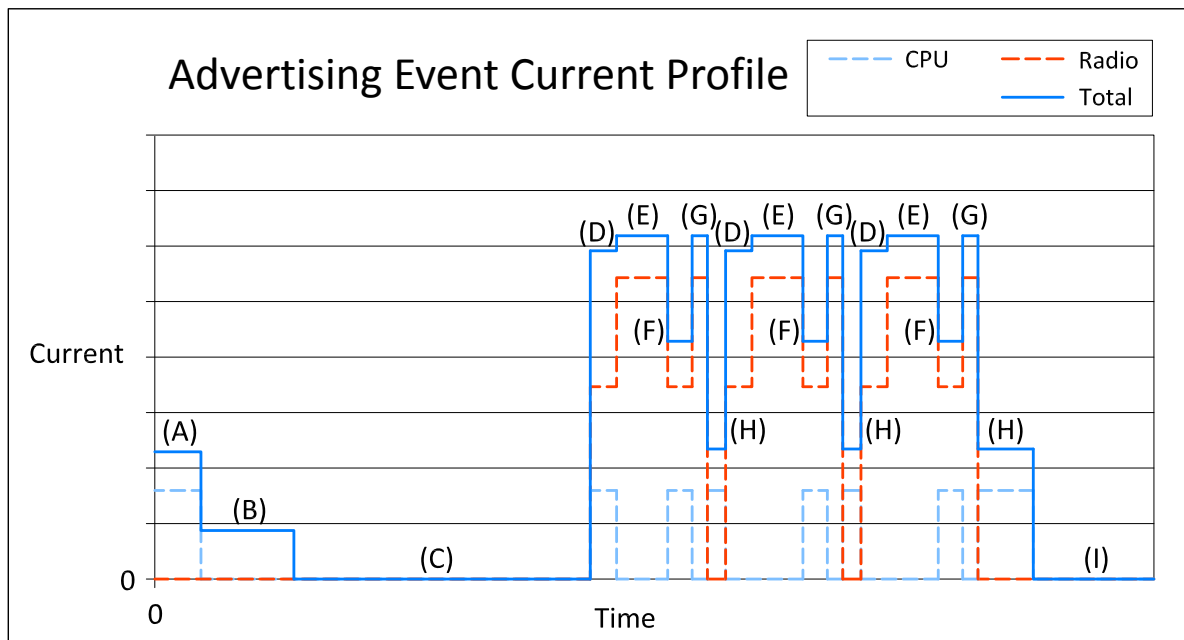

Figure 59: Advertising event

Stage	Description
(A)	Pre-processing (CPU)
(B)	Standby + HFXO ramp
(C)	Standby
(D)	Radio startup
(E)	Radio TX
(F)	Radio switch
(G)	Radio RX
(H)	Post-processing (CPU)
(I)	Standby

Table 42: Advertising event

## 18.2 Peripheral connection event

This section gives an overview of the power profile of the peripheral connection event implemented in the SoftDevice.

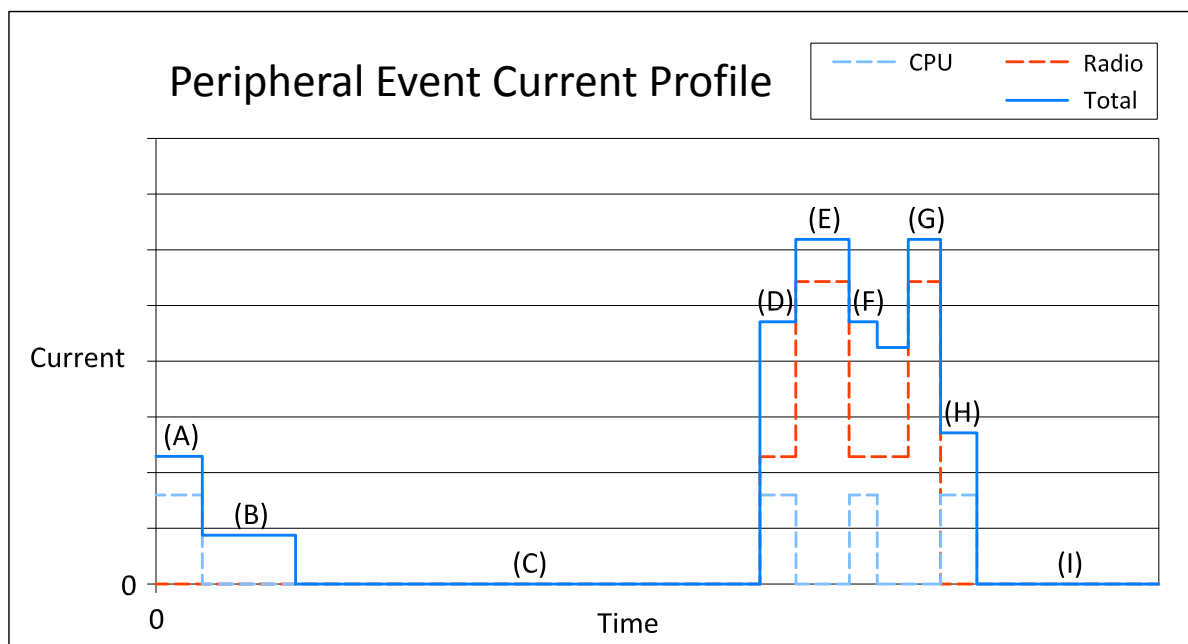

Figure 60: Peripheral connection event

Stage	Description
(A)	Pre-processing (CPU)
(B)	Standby + HFXO ramp
(C)	Standby
(D)	Radio startup
(E)	Radio RX
(F)	Radio switch
(G)	Radio TX
(H)	Post-processing (CPU)
(I)	Standby

Table 43: Peripheral connection event

## 18.3 Scanning event

This section gives an overview of the power profile of the scanning event implemented in the SoftDevice. [Figure 61: Scanning event](#) on page 103 shows the current profile for a scan event. When the SoftDevice receives a packet, it transitions from stage E to stage F. For each advertising packet the SoftDevice receives, the sequence D-F is added to the current profile. For each secondary channel advertising packet the scanner receives, the sequence A-F is added to the current profile.

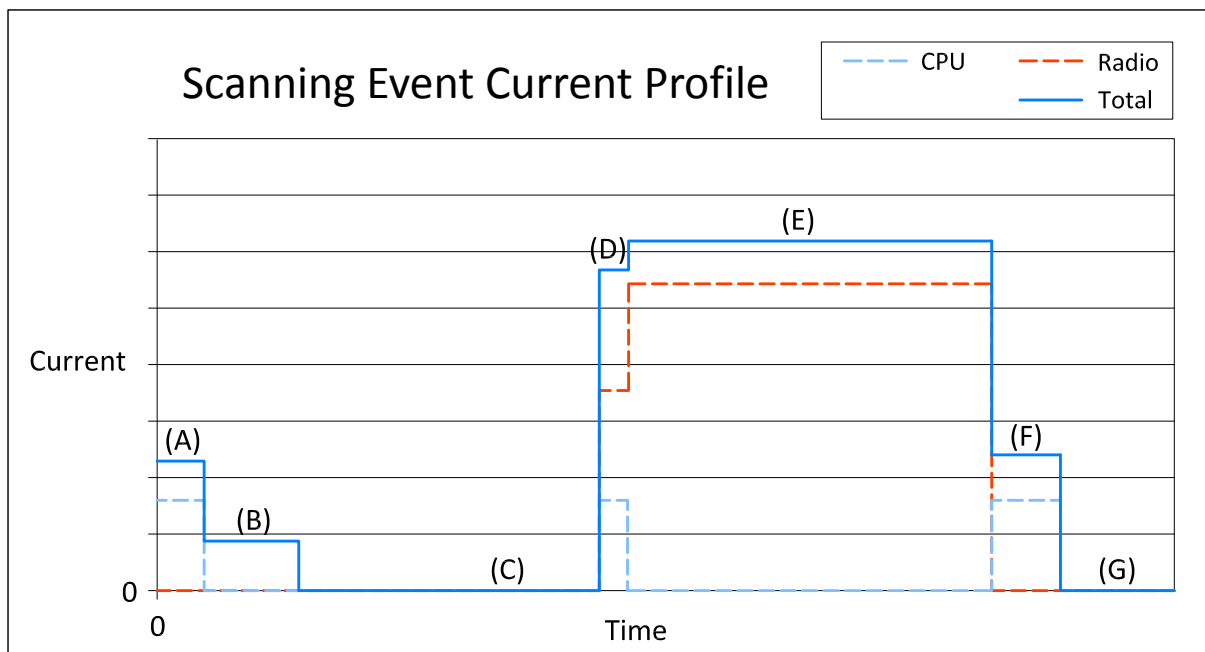

Figure 61: Scanning event

Stage	Description
(A)	Pre-processing (CPU)
(B)	Standby IDLE + HFXO ramp
(C)	Standby
(D)	Radio startup
(E)	Radio RX
(F)	Post-processing (CPU)
(G)	Standby

Table 44: Scanning event

## 18.4 Central connection event

This section gives an overview of the power profile of the central connection event implemented in the SoftDevice.

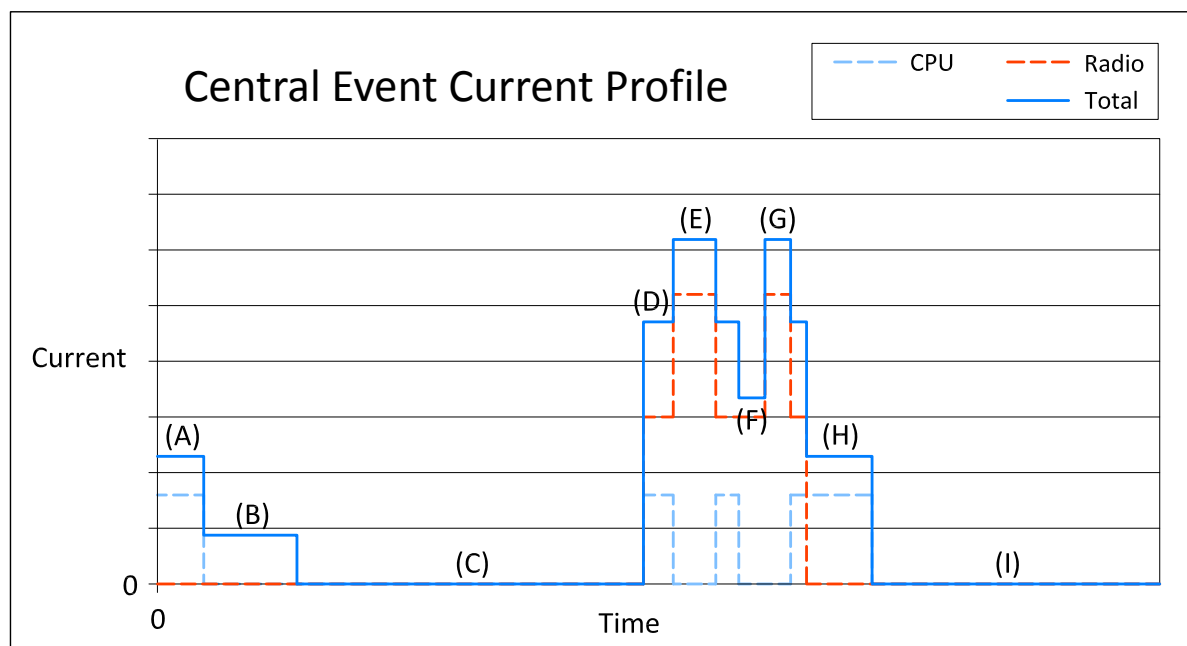

Figure 62: Central connection event



Stage	Description
(A)	Pre-processing (CPU)
(B)	Standby + HFXO ramp
(C)	Standby
(D)	Radio startup
(E)	Radio TX
(F)	Radio switch
(G)	Radio RX
(H)	Post-processing (CPU)
(I)	Standby

*Table 45: Central connection event*

# 19

## SoftDevice identification and revision scheme

The SoftDevices are identified by the SoftDevice part code, a qualified IC partcode (for example, nRF52832), and a version string.

The identification scheme for SoftDevices consists of the following items:

- For revisions of the SoftDevice which are production qualified, the version string consists of major, minor, and revision numbers only, as described in the table below.
- For revisions of the SoftDevice which are not production qualified, a build number and a test qualification level (alpha/beta) are appended to the version string.
- For example: s110\_nrf51\_1.2.3-4.alpha, where the major version is 1, minor version is 2, revision number is 3, build number is 4, and test qualification level is alpha. For more examples, see [Table 47: SoftDevice revision examples](#) on page 106.

Revision	Description
Major increments	<p>Modifications to the <i>API</i> or the function or behavior of the implementation or part of it have changed.</p> <p>Changes as per minor increment may have been made.</p> <p>Application code will not be compatible without some modification.</p>
Minor increments	<p>Additional features and/or <i>API</i> calls are available.</p> <p>Changes as per minor increment may have been made.</p> <p>Application code may have to be modified to take advantage of new features.</p>
Revision increments	<p>Issues have been resolved or improvements to performance implemented.</p> <p>Existing application code will not require any modification.</p>
Build number increment (if present)	New build of non-production versions.

Table 46: Revision scheme

Sequence number	Description
s110_nrf51_1.2.3-1.alpha	Revision 1.2.3, first build, qualified at alpha level
s110_nrf51_1.2.3-2.alpha	Revision 1.2.3, second build, qualified at alpha level
s110_nrf51_1.2.3-5.beta	Revision 1.2.3, fifth build, qualified at beta level
s110_nrf51_1.2.3	Revision 1.2.3, qualified at production level

Table 47: SoftDevice revision examples

Qualification	Description
Alpha	<ul style="list-style-type: none"> <li>• Development release suitable for prototype application development</li> <li>• Hardware integration testing is not complete</li> <li>• Known issues may not be fixed between alpha releases</li> <li>• Incomplete and subject to change</li> </ul>
Beta	<ul style="list-style-type: none"> <li>• Development release suitable for application development</li> <li>• In addition to alpha qualification: <ul style="list-style-type: none"> <li>• Hardware integration testing is complete</li> <li>• Stable, but may not be feature complete and may contain known issues</li> <li>• Protocol implementations are tested for conformance and interoperability</li> </ul> </li> </ul>
Production	<ul style="list-style-type: none"> <li>• Qualified release suitable for production integration</li> <li>• In addition to beta qualification: <ul style="list-style-type: none"> <li>• Hardware integration tested over supported range of operating conditions</li> <li>• Stable and complete with no known issues</li> <li>• Protocol implementations conform to standards</li> </ul> </li> </ul>

Table 48: Test qualification levels

## 19.1 Master boot record distribution and revision scheme

The MBR is distributed in each SoftDevice hex file.

The version of the MBR distributed with the SoftDevice will be published in the release notes for the SoftDevice and uses the same major, minor, and revision-numbering scheme as described here.

# Glossary

## **Application Programming Interface (API)**

A language and message format used by an application program to communicate with an operating system, application, or other service.

## **Attribute Protocol (ATT)**

“The attribute protocol allows a device referred to as the server to expose a set of attributes and their associated values to a peer device referred to as the client.” [Bluetooth Core Specification, Version 5.0, Vol 3, Part F, Section 1.1](#)

## **Cortex Microcontroller Software Interface Standard (CMSIS)**

A vendor-independent hardware abstraction layer for the Cortex-M processor series that defines generic tool interfaces.

## **Device Firmware Update (DFU)**

A mechanism for upgrading the firmware of a device.

## **Floating-Point Unit (FPU)**

A part of a CPU specially designed to perform operations on floating point numbers.

## **Generic Access Profile (GAP)**

“The Bluetooth system defines a base profile which all Bluetooth devices implement. This profile is the Generic Access Profile (GAP), which defines the basic requirements of a Bluetooth device.” [Bluetooth Core Specification, Version 5.0, Vol 1, Part A, Section 6.2](#)

## **Generic Attribute Protocol (GATT)**

“Generic Attribute Profile (GATT) is built on top of the Attribute Protocol (ATT) and establishes common operations and a framework for the data transported and stored by the Attribute Protocol.” [Bluetooth Core Specification, Version 5.0, Vol 1, Part A, Section 6.4](#)

## **Human Interface Device (HID)**

Type of a computer device that interacts directly with, and most often takes input from, humans and may deliver output to humans. The term "HID" most commonly refers to the USB-HID specification.

## **Integrated Circuit (IC)**

A semiconductor chip consisting of fabricated transistors, resistors, and capacitors.

## **Link Layer (LL)**

“A control protocol for the link and physical layers that is carried over logical links in addition to user data.” [Bluetooth Core Specification, Version 5.0, Vol 1, Part A, Section 1.2](#)

## **Low Noise Amplifier (LNA)**

An electronic amplifier that amplifies a very low-power signal without significantly degrading its signal-to-noise ratio.

## **Logical Link Control and Adaptation Protocol (L2CAP)**

“Provides a channel-based abstraction to applications and services. It carries out segmentation and reassembly of application data and multiplexing and de-multiplexing of multiple channels over a shared logical link.” *Bluetooth Core Specification, Version 5.0, Vol 1, Part A, Section 1.2*

### **Main Stack Pointer (MSP)**

The default stack pointer. By default, the nRF52 has a shared call stack for the application and the SoftDevice, managed by the *MSP*.

### **Man-in-the-Middle (MITM)**

A man-in-the-middle attack is a form of eavesdropping where communication between two devices is monitored and modified by an unauthorized party who relays information between the two devices giving the illusion that they are directly connected.

### **Memory Watch Unit (MWU)**

A peripheral that can be used to generate events when a memory region is accessed by the CPU.

### **Power Amplifier (PA)**

A device used to increase the transmit power level of a radio signal.

### **Programmable Peripheral Interconnect (PPI)**

Enables peripherals to interact autonomously with each other using tasks and events independent of the CPU.

### **Process Stack Pointer (PSP)**

A separate stack pointer that can be used for application threads. This is an optional configuration, but it may be required if using an RTOS.

### **Qualified Design Identification (QDID)**

A unique identifier assigned to a design that has completed *Bluetooth* Qualification.

### **Quality of Service (QoS)**

A module in the SoftDevice that is dedicated to providing various signal quality measurements. The application can use this data to estimate the quality of received signal.

### **Software Development Kit (SDK)**

A set of tools used for developing applications for a specific device or operating system.

### **SoftDevice Manager (SDM)**

A SoftDevice component that controls the SoftDevice state and configures the behavior of certain core functionality.

### **Security Manager (SM)**

Provides means for bonding devices, encrypting and decrypting data, and enabling device privacy.

### **Security Manager Protocol (SMP)**

A protocol used for pairing and key distribution.

### **System on Chip (SoC)**

A microchip that integrates all the necessary electronic circuits and components of a computer or other electronic systems on a single integrated circuit.

**Supervisor Call (SVC)**

Generates a software exception in which access to system resources or privileged operations can be provided.

# Acronyms and abbreviations

These acronyms and abbreviations are used in this document.

**API**

Application Programming Interface

**ATT**

Attribute Protocol

**CMSIS**

Cortex Microcontroller Software Interface Standard

**DFU**

Device Firmware Update

**FPU**

Floating-Point Unit

**GAP**

Generic Access Profile

**GATT**

Generic Attribute Protocol

**GPIO**

General-Purpose Input/Output

**GPiOTE**

General-Purpose Input/Output Tasks and Events

**HFCLK**

High-Frequency Clock

**HFXO**

High-Frequency Crystal Oscillator

**HID**

Human Interface Device

**IC**

Integrated Circuit

**IRQ**

Interrupt Request

**LFCLK**

Low-Frequency Clock

**LL**

Link Layer

**LNA**

Low Noise Amplifier

**L2CAP**

Logical Link Control and Adaptation Protocol

**MBR**

Master Boot Record

**MITM**

Man-in-the-Middle

**MSP**

Main Stack Pointer

**MTU**

Maximum Transmission Unit

**MWU**

Memory Watch Unit

**NVIC**

Nested Vectored Interrupt Controller

**PA**

Power Amplifier

**PDU**

Packet Data Unit

**PPI**

Programmable Peripheral Interconnect

**PSP**

Process Stack Pointer

**QDID**

Qualified Design Identification

**QoS**

Quality of Service

**RC**

Resistor-Capacitor

**SDK**

Software Development Kit

**SDM**

SoftDevice Manager

**SM**

Security Manager

**SMP**

Security Manager Protocol

**SoC**

System on Chip

**SVC**

Supervisor Call



**UUID**

Universally Unique Identifier

# Legal notices

By using this documentation you agree to our terms and conditions of use. Nordic Semiconductor may change these terms and conditions at any time without notice.

## Liability disclaimer

Nordic Semiconductor ASA reserves the right to make changes without further notice to the product to improve reliability, function or design. Nordic Semiconductor ASA does not assume any liability arising out of the application or use of any product or circuits described herein.

All information contained in this document represents information on the product at the time of publication. Nordic Semiconductor ASA reserves the right to make corrections, enhancements, and other changes to this document without notice. While Nordic Semiconductor ASA has used reasonable care in preparing the information included in this document, it may contain technical or other inaccuracies, omissions and typographical errors. Nordic Semiconductor ASA assumes no liability whatsoever for any damages incurred by you resulting from errors in or omissions from the information included herein.

## Life support applications

Nordic Semiconductor products are not designed for use in life support appliances, devices, or systems where malfunction of these products can reasonably be expected to result in personal injury.

Nordic Semiconductor ASA customers using or selling these products for use in such applications do so at their own risk and agree to fully indemnify Nordic Semiconductor ASA for any damages resulting from such improper use or sale.

## RoHS and REACH statement

Nordic Semiconductor products meet the requirements of *Directive 2011/65/EU of the European Parliament and of the Council on the Restriction of Hazardous Substances (RoHS 2)* and the requirements of the *REACH* regulation (EC 1907/2006) on Registration, Evaluation, Authorization and Restriction of Chemicals.

The SVHC (Substances of Very High Concern) candidate list is continually being updated. Complete hazardous substance reports, material composition reports and latest version of Nordic's REACH statement can be found on our website [www.nordicsemi.com](http://www.nordicsemi.com).

## Trademarks

All trademarks, service marks, trade names, product names and logos appearing in this documentation are the property of their respective owners.

## Copyright notice

© 2018 Nordic Semiconductor ASA. All rights are reserved. Reproduction in whole or in part is prohibited without the prior written permission of the copyright holder.

